



Systems and Components for Roof Landscapes

Product List 2015

Life on Roofs



Table of Contents

<i>Slip Sheet and Separation Membrane</i>	3
<i>Root Barrier / Accessories</i>	4
<i>Protection Mats</i>	6
<i>Drainage Elements</i>	8
<i>Building Protection and Drainage Elements</i>	11
<i>Drainage Elements/ Protection Mats</i>	12
<i>Filter Sheets</i>	13
<i>Mineral Substrates</i>	14
<i>System Substrates</i>	15
<i>Substrates in Bags</i>	16
<i>Fertilizer / Seed Mixtures</i>	17
<i>Pitched Green Roofs</i>	18
<i>Steep Pitched Green Roofs</i>	19
<i>System Build-up "Summer Plains"</i>	20
<i>Inspection Chambers</i>	21
<i>Irrigation Units / Accessories</i>	23
<i>Drainage Channels</i>	24
<i>Balcony and Terrace Channels / System Gutters</i>	25
<i>Terrace Grills</i>	26
<i>Separations / Eaves Profile</i>	27
<i>Gravel Retainer / Separation Profile</i>	29
<i>Clamping and Protection Profile</i>	30
<i>Fall Protection</i>	31
<i>Guardrail Solutions</i>	33
<i>Photovoltaics and Green Roofs</i>	35
<i>Accessories Photovoltaics and Green Roofs</i>	36
<i>Vertically Adjustable Pedestals</i>	37
<i>Accessories for Pedestals</i>	38
<i>Accessories for Slab Pavements</i>	39
<i>European Technical Approval</i>	40

Inspection Chambers, Irrigation Units and Accessories

Page 21



Drainage Channels, Balcony and Terrace Channels, Terrace Grills

Page 24



Separations, Eaves Profiles, Gravel Retainer, Clamping and Protection Profiles

Page 27



Fall Protection and Guardrail Solutions

Page 31



Vertically Adjustable Pedestals

Page 37



Photovoltaics and Green Roofs

Page 35



Please note that this English Version of the Product List is for your information only, but is composed of

1. "German" Engineering
 2. German Trademarks and Patents
- and therefore must be adapted to the needs of each market.

Slip Sheet and Separation Membrane

Separation and slip sheets, as loosely laid tarps or sheets, protect the waterproofing from tensile and shear forces. In the case of chemically incompatible materials (e.g. single soft PVC sheets on bitumen), a neutral separation layer has to be installed. Only permeable membranes (e.g. TGV 21), and not vapour barriers, should be used over an XPS insulation in inverted roof constructions, in order to avoid condensation within the insulation.

Slip Sheet TGF 20



Chemically neutral high-pressure-polyethylene sheet for application as separation and slip sheet on green roofs, for walkways and driveways; compatible with bitumen and polystyrene; resistant to most chemicals; UV-stabilized; smooth surface; vapour barrier ($S_d \geq 100$ m); black: colour; thickness: ca. 0.20 mm; weight: ca. 190 g/m².

	Art.-No.	Dimensions	Unit	Pallet
TGF 20	1020	ca. 8.00 m × 25.00 m	200 m ² roll	6600 m ²
	1022	ca. 3.00 m × 33.50 m	100.5 m ² roll	2211 m ²

Other dimensions available upon request.

Separation Membrane TGV 21 (Diffusion Membrane)



Air and vapour permeable membrane; water-repellent; thermally bound; made of 100 % polypropylene; can be used as a separation layer and as protection against **small particle infiltration**, e.g. on inverted green roofs, as metal protection against harmful effects of adjoining materials, etc. Chemically and biologically neutral; compatible with bitumen and polystyrene; resistant to acids and alkalis; permeable to vapour ($S_d < 0.01$ m); black: colour; thickness: ca. 0.55 mm; weight: ca. 80 g/m².

	Art.-No.	Dimensions	Unit	Pallet
TGV 21	2180	ca. 1.60 m × 250.00 m	400 m ² roll	3600 m ²
	2185	ca. 1.60 m × 50.00 m	80 m ² roll	1600 m ²

Root Barrier / Accessories

Root barriers, as loosely laid tarps or welded sheets, protect the waterproofing from root penetration. This protection is mainly necessary for bituminous waterproofings. The hot-air-weldable Root Barrier WSB 100-PO is used on complicated roof areas with many upstands, penetrations, etc. and on intensive green roofs. Large-size tarps of Root Barrier WSF 40 made of special polyethylene, laid with 1.5 m overlap, are suitable for simple extensive green roof areas. In general the material compatibility of the root barrier and the waterproofing has to be taken into account. ZinCo Root Barriers WSF 40 and WSB 100-PO are compatible with bitumen.

Root Barrier WSF 40



10-year
root barrier warranty
in combination
with SSM 45 *

High-pressure polyethylene sheet, solid and with high tensile strength, for application as loosely laid root barrier mainly on extensive green roofs and in planters. Root proof; compatible with bitumen and polystyrene; free of plasticizer; resistant to humic acids and oil; UV-stabilized; Water vapour permeability of air layer thickness according to German Standard DIN 52615: $sd \geq 200$ m; black: colour; thickness: ca. 0.36 mm; weight: ca. 310 g/m².

	Art.-No.	Dimensions	Unit	Pallet
WSF 40	1040	ca. 8.00 m × 25.00 m	200 m ² roll	4600 m ²
	1041	ca. 6.25 m × 20.00 m	125 m ² roll	2500 m ²
	1043	ca. 2.00 m × 50.00 m	100 m ² roll	2600 m ²
	1044	ca. 3.00 m × 33.50 m	100,5 m ² roll	2211 m ²
	41040	ca. 6.25 m × 3.20 m	20 m ²	600 m ²

Root Barrier WSB 100-PO



10-year
root barrier warranty
in combination
with ISM 50 *

Root Barrier made of flexible Polyolefin (FPO); compatible with bitumen, polyester scrim reinforced; flexible at low temperatures; hot-air-weldable; tested for root and rhizome resistance in accordance with FLL testing procedures; UV-stabilized for storage purposes, however not UV resistant in the long term; light grey colour; tensile strength > 8 N/mm²; elongation at rupture > 20 %; thickness: ca. 1.10 mm; weight: ca. 1.13 kg/m².

	Art.-No.	Dimensions	Unit	Pallet
WSB 100-PO	1084	ca. 2.44 m × 30.50 m	74.40 m ² roll	1116 m ²



Details on page 40



* Please note our warranty conditions which will be sent to you upon request.

Root Barrier / Accessories

Prefabricated Corner and Unsupported Flashing



Prefabricated corner made of FPO, used for Root Barrier WSB 100-PO; compatible with bitumen. Combined inner/outer corner. Any material not needed is simply cut off, so that the part can be used either as an inner or an outer corner. The Unsupported Flashing without the polyester scrim reinforcement is used for flashing details.

	Art.-No.	Dimensions	Unit
Combined External (EC) and Combined Internal (IC) Corner	1192		Piece
Unsupported Flashing	1195	ca. 0.60 m × 15.00 m weight: ca. 9 kg	Roll

Clamping Profile AP 40



Clamping profile, e.g. for fixation of root barriers, or pond liners to concrete kerbs or planters, made of aluminium; pre-drilled holes, spacing between the holes ca. 200 mm. Profile height: ca. 40 mm.

	Art. No.	Length	Unit
AP 40	7620	ca. 3.00 m	Bundle of 10 pieces

Roof Dam Element PE



A Roof Dam Element of a 0° flat roof provides long term irrigation, and is recommended mainly for intensive green roofs. It has a flange made of polyethylene to be welded into waterproofing membranes or root barriers made of FPO (e.g. root barrier WSB 100-PO); with detachable copper extension piece; includes sealing ring; extension piece for water dam-up level of ca. 40 mm. Extension pieces for other water levels are available upon request. Diameter of opening: ca. 90 mm; weight ca. 0.5 kg.

	Art. No.	Unit
Roof Dam Element PE	4142	Piece

Foil-Welding-Set



Complete accessory set for hot air welding of root barrier, waterproofing or pond sheets and for joint welding of PVC-sheets. Delivered in a solid aluminium case. Contains: hot-air-fan with two jets, brush bottle for solution welding compound, spray bottle for liquid foil, pressing roll, gloves, protection glasses, mouth mask, compound action, tin snips, blade knife, scissors, screwdriver, ruler, funnel, operating instructions.

	Art.-No.	Unit
Foil-Welding-Set	9520	Aluminium Case

System-Adhesive Tape 40



Special double sided self-adhesive tape to bond foil and sheet to bituminous surfaces, flashings, or concrete. Ask an installation aid, joint is not root resistant.

	Art.-No.	Width	Unit	Pack
System-Adhesive Tape 40	9500	ca. 40 mm	40 m rolls	120 m

Protection Mats

Protection Mats protect root barriers or root-resistant waterproofing from mechanical damages (necessary according to German Standard DIN 18195 T5, e.g. for single layer plastic waterproofing). The mats also function as water and nutrient reservoirs and reduce subsonic noise. Protection Mats TSM 32 and SSM 45 are mainly used for extensive green roofs. On intensive green roofs and under hard surfaces, the solid Protection Mat ISM 50 and the thicker Protection Mat BSM 64 are recommended.

In general, protection mats have to be installed with an overlap of at least 100 mm. The installation of a double layer increases the protection and water storage capacity.

Protection Mat TSM 32



Details on page 40

Non-rotting, synthetic fibre mat made of polyester; used as protection layer, in accordance with German Standard DIN 18195, on root barrier or waterproofing of extensive green roofs; water and nutrient storage; compatible with bitumen; biologically and chemically neutral; heat-resistant; tear proof; made of recycled material. With proven protection efficiency in accordance with European Standards EN ISO 13428. Strength class 3; melting point: ca. 260 °C; water storage capacity: ca. 3 l/m²; thickness: ca. 3 mm; weight: ca. 350 g/m².

	Art.-No.	Dimensions	Unit	Pallet
TSM 32	2032	ca. 2.00 m × 50.00 m	100 m ² roll	
	42035	ca. 2.00 m × 10.00 m	20 m ² roll	600 m ²

Protection Mat SM-R



Protection mat strips made of polyester fibres, to be used at roof upstands and in connecting areas. Ideal in combination with Fixodrain® XD 20. The rear side is sprayed with pressure-sensitive adhesive to ease the assembly process; compatible with bitumen, biologically and chemically neutral; thickness: ca. 3 mm; weight: ca. 320 g/m².

	Art.-No.	Dimensions	Unit
SM-R	2035	ca. 0.50 m × 25.00 m	12.5 m ² roll

Protection Mat SSM 45



Details on page 40

High quality synthetic fibre mat made of polyester/polypropylene mixture, used as protection layer, in accordance with German Standard DIN 18195, on root barrier (part of the ZinCo root barrier system "E") or waterproofing of extensive green roofs; water and nutrient storage; compatible with bitumen; biologically and chemically neutral; non-rotting; tear proof; made of recycled material. With proven protection efficiency in accordance with European Standards EN ISO 13428. CBR-Test according to European Standard EN ISO 12236: penetration resistance > 2000 N (strength class 3); strip tension test according to European Standard EN ISO 10319: tensile strength lengthwise > 5.5 kN/m; extension lengthwise > 75 %; water storage capacity: ca. 5 l/m²; thickness: ca. 5 mm; weight: ca. 470 g/m².

	Art.-No.	Dimensions	Unit
SSM 45	2045	ca. 2.00 m × 50.00 m	100 m ² roll

Protection Mats

Protection Mat BSM 64



Non-rotting, synthetic fibre mat made of polyester/polypropylene mixture, with stabilising carrier sheet inlay; used as protection layer on root barrier or waterproofing; extremely high water storage capacity; compatible with bitumen; biologically and chemically neutral; tear proof; made of recycled material. With proven protection efficiency in accordance with European Standards EN ISO 13428. Strength class 4; water storage capacity ca. 7 l/m²; thickness ca. 7 mm; weight ca. 650 g/m².

	Art.-No.	Dimensions	Unit
BSM 64	2064	ca. 2.00 m × 25.00 m	50 m ² roll

Protection Mat WSM 150



Non-rotting, thermally reinforced needle fleece mat made of mixed fibres; used as water storage mat on green roofs, especially on pitched roofs; extremely high water storage capacity; compatible with bitumen; biologically and chemically neutral; tear proof; made of recycled fibres; water storage capacity ca. 12 l/m², thickness ca. 17 mm; weight ca. 1500 g/m².

	Art. No.	Dimensions	Unit
WSM 150	2015	ca. 1.00 m × 15.00 m	15 m ² roll

Protection Mat ISM 50



Non-rotting, synthetic mat made of polyester/polypropylene mixture with high mechanical durability; with bottom sided fiber bonding using acrylic dispersions, and therefore easy to be glued; water and nutrient storage; used for intensive green roofs (part of the ZinCo Root Barrier System "I") and under walkways and driveways; compatible with bitumen; biologically neutral; spade-resistant; made of recycled material; reduces subsonic noise (VM: +25 dB, with gravel and concrete pavers).

CBR-Test in accordance with European Standard EN ISO 12236: penetration resistance (average) > 3500 N (strength class 5); water storage capacity ca. 4 l/m²; thickness ca. 6 mm; weight ca. 850 g/m².



Details on page 40

	Art. No.	Dimensions	Unit
ISM 50	2050	ca. 2.00 m × 25.00 m	50 m ² roll

Elastosave ES 30



Ideal protection
e.g. under Elefeet®
page 37

High quality, extra slim protection mat made of recycled rubber, for full-surface installation onto roof waterproofing. The tensile strength of ca. 0.8 N/mm² is twice that of common chip rubber mats, and the elongation at rupture of 125 % is three times greater.

On bitumen layers the surface has to be swept clean. The ES 30 has to be installed with an overlap of 50 mm. In the case of synthetic roof waterproofing, it should be checked for rubber compatibility (generally this means the presence of bitumen-compatible tracks). If incompatible, an additional separation layer (ZinCo TGF 20) is required.

Thickness ca. 3 mm; weight ca. 3 kg/m²; temperature resistant from -30 °C to +80 °C.

	Art. No.	Dimensions	Unit	Pallet
Elastosave ES 30	2094	ca. 1.25 m × 8.00 m	10 m ² roll	240 m ²

Drainage Elements

The Floradrain® System has been developed especially for landscaped flat roofs. The molded elements of thermoformed recycled polyolefin can store rainwater in water storage cells on the upper side and drain off excess water below. The necessary aeration of the root space is ensured. Floradrain® FD 25-E is particularly suitable for extensive green roofs with a slope while Floradrain® FD 40-E is also suitable for intensive green roofs and for terraces. With Floradrain® FD 60, green roofs with a water dam-up can be created on 0°-roofs. Floradrain® in rolls is ideal for use on barrel roofs. Stabilodrain® SD 30 elements have been developed with a high load-bearing capacity (e.g. for use on parking lots, driveways). The Fixodrain® XD 20 drainage sheet is mainly used for landscaping large industrial roofs. The thin DBV 12 studded sheet is mainly used as a drainage and protective layer, e.g. under terraces.

Floradrain® FD 25-E

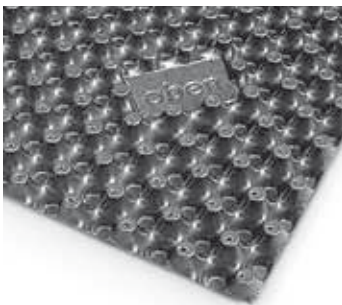

Drainage and water storage element for use under extensive and simple intensive green roofs as well as under walkways and terraces; made of thermoformed recycled polyolefin (https. PE); waterstorage cells; openings for aeration and diffusion, with channel system on the underside. In-plane water flow rate tested according to European Standard DIN EN ISO 12958. Compatible with bitumen and pressure resistant; butt joint installation; connection with clamps is possible. Compressive strength: ca. 270 kN/m²; filling volume: ca. 10 l/m²; weight: ca. 1.7 kg/m²; height: ca. 25 mm.

	Art. No.	Dimensions	Unit	Pallet
FD 25-E	3028	ca. 1.00 m × 2.00 m	2.00 m ² board	300 boards

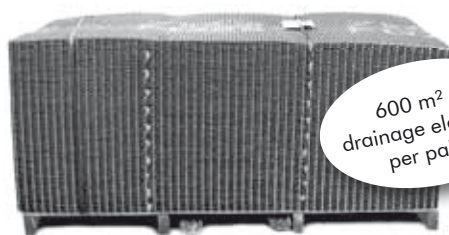

Applies for any Floradrain® FD 25 products

Details on page 40

Floradrain® FD 25-R

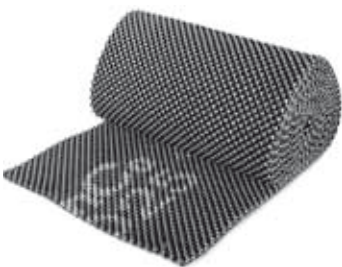

Floradrain® FD 25-R on rolls, e.g. for landscaping barrel roofs. Floradrain® FD 25-R can be applied continuously and therefore can bear the tensile forces. Standard length: 15 m; material: recycled polyolefin (https. PE).

	Art. No.	Dimensions	Unit
FD 25-R (Roll)	3023	ca. 1.00 m × 15.00 m	15 m ² roll

Floradrain® FD 25-RV



Floradrain® FD 25-RV is available with a filter sheet attached to the upper side, for efficient green roof installation. The filter sheet overlaps by ca. 100 mm along one side. Please note the greater transport volume of the rolls compared with the boards. Material: recycled polyolefin (https. PE).

	Art. No.	Dimensions	Unit
FD 25-RV (Roll & Filter Sheet)	3022	ca. 1.00 m × 15.00 m	15 m ² roll

Drainage Elements

Floradrain® FD 40-E



Drainage and water storage element made of thermoformed Material: recycled polyolefin (htps. PE), with waterstorage cells, openings for aeration and diffusion; with channel system on the underside. In-plane water flow rate tested according to European Standard DIN EN ISO 12958. Compatible with bitumen and pressure resistant; butt joint installation; connection with clamps is possible. Floradrain® FD 40-E is used under extensive and simple intensive green roofs as well as under walkways and terraces, even without a slope. Compressive strength: ca. 135 kN/m²; filling volume: ca. 17 l/m²; weight: ca. 2.1 kg/m²; height: ca. 40 mm.

	Art. No.	Dimensions	Unit	Pallet
FD 40-E	3041	ca. 1.00 m x 2.00 m	2.00 m ² board	250 boards

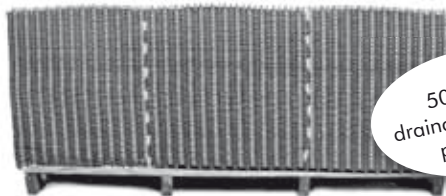

500 m² of drainage elements per pallet



Details on page 40

Applies for any Floradrain® FD 40 products

Floradrain® FD 40-R



Floradrain® FD 40-R on rolls, e.g. for landscaping barrel roofs. Floradrain® FD 40-R can be applied continuously and therefore can bear the tensile forces. Height ca. 40 mm; standard length: 10.70 m; material: recycled polyolefin (htps. PE).

	Art. No.	Dimensions	Unit
FD 40-R (Roll)	3043	ca. 0.94 m x 10.70 m	10 m ² roll

Floradrain® FD 40-RV



Floradrain® FD 40-RV is available with a filter sheet attached to the upper side, for efficient green roof installation. The filter sheet overlaps by ca. 100 mm along one side. Please note the greater transport volume of the rolls compared with the boards. Material: recycled polyolefin (htps. PE).

	Art. No.	Dimensions	Unit
FD 40-RV (Roll & Filter Sheet)	3042	ca. 0.94 m x 10.70 m	10 m ² roll

Connectors for FD 25-E and FD 40-E

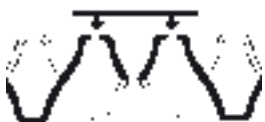

For a safe and stable connection of Floradrain® sheets; to be pressed into the diffusion openings, made of yellow plastic. Recommended quantity: ca. 2 connectors/m².

	Art. No.	Unit
Connector for FD 25-E and FD 40-E	9620	Bag of 100 pieces

Drainage Elements

Floradrain® FD 60

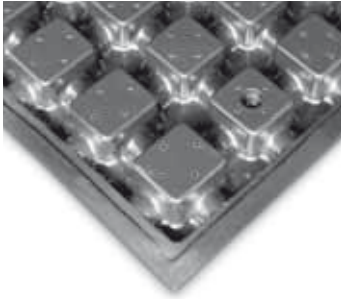

Drainage and water storage element made of thermoformed Recycling-ABS-hard plastic, with particularly deep water storage cells; used for intensive green roofs with up to 40 mm water dam-up, under walkways and terraces. As formwork element for concrete or further build-up for driveways, fire brigade access, etc. In-plane water flow rate tested according to European Standard DIN EN ISO 12958. Very solid and pressure-resistant; installation with overlapping, therefore ca. 3 % surplus required. Compressive strength: ca. 75 kN/m² (infilled); filling volume: ca. 27 l/m²; weight: ca. 2.3 kg/m²; height: ca. 60 mm.

	Art. No.	Dimensions	Unit	Pallet
FD 60	3060	ca. 1.00 m × 2.00 m	2.00 m ² board	100 boards

Floradrain® FD 60 natureline

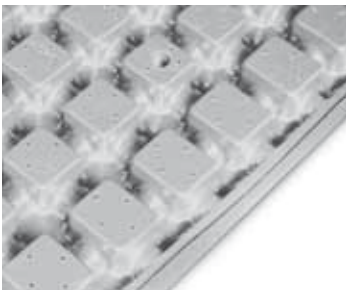

natureline made of renewable raw materials



Drainage and water storage element made of renewable raw materials to at least 95 %, height ca. 60 mm, with water storage cells and openings for ventilation and evaporation as well as multidirectional drainage channel system on the underside, in-plane water flow capacity tested according to EN ISO 12958, delivery and installation according to manufacturer's instructions. ZinCo has been awarded third place in the innovation competition "Bio-based Material of the Year 2014" for this product.

	Art. No.	Dimensions	Unit	Pallet
FD 60	306090	ca. 1.00 m × 2.00 m	Platte á 2.00 m ²	100 Platten

Stabilodrain® SD 30



Drainage and water storage element made of thermoformed polystyrene, used for driveways and parking lots; can be installed on inverted roofs. In-plane water flow rate tested according to European Standard DIN EN ISO 12958. Extremely solid; maximum load bearing capacity (without infilling) ca. 500 kN/m²; installation with overlapping, therefore ca. 3 % surplus required; weight: ca. 3 kg/m²; height: ca. 32 mm. Specially shaped lateral studs allow for interlocking connection of the boards.

	Art. No.	Dimensions	Unit	Pallet
SD 30	3330	ca. 0.94 m × 2.00 m	1.88 m ² board	100 boards

Fixodrain® XD 20

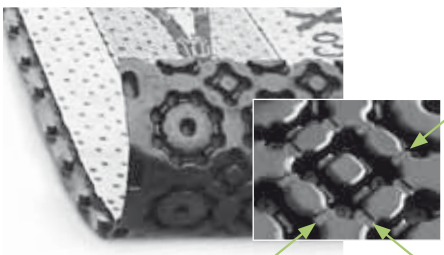

Quick-to-lay protection, drainage and water storage element made of thermoformed recycled polyolefin with attached filter sheet, to be used under extensive green roofs; with interlocking studs for connection on its long side. Also suitable for inverted roofs due to the diffusion openings and underlying connected channels. In-plane water flow rate tested according to European Standard DIN EN ISO 12958. Colour: dark grey/white colour; height: ca. 20 mm; weight: ca. 1.0 kg/m²; max. load bearing capacity: ca. 50 kN/m²; water storage capacity: ca. 3 l/m².

	Art. No.	Dimensions	Unit
XD 20	3021	ca. 1.00 m × 20.00 m	20 m ² roll



Details on page 40

Building Protection and Drainage Elements

Protectodrain® with its rubber protection mat provides proven protection for the waterproofing and is also a stable drainage board. This ensures efficient drainage of surplus water and protection of the vegetation from water logging. Despite the fact that it comprises two parts, Protectodrain® can be easily disassembled into its components, therefore allowing for appropriate disposal. Elastodrain® elements are made of solid rubber and are trafficable with wheel loaders. Elastodrain sheets are mainly used on underground garage roofs. They serve as a protection and drainage layer under green areas as well as under walkways and driveways. Elastodrain® strips can be used as a base for terrace slabs or as protection sheets at the edges of green areas.

Protectodrain® PD 250

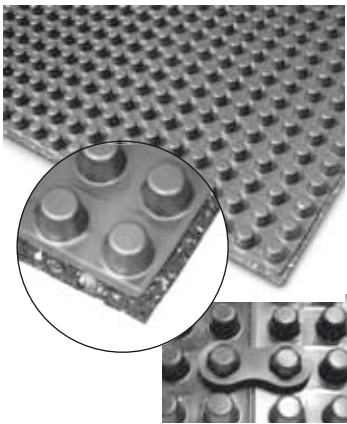

Stable and heavy duty drainage board made of thermoformed hard plastic (ABS) with attached rubber protection mat on the underside and all-round overlap. One-sided stud structure. Easy to transport due to light weight! Can be used as a protective layer in accordance with German Standard DIN 18 195, providing a drainage function at the same time, e.g. under landscaped underground garage roofs, terraces, etc.. In-plane water flow rate tested according to European Standard DIN EN ISO 12958. Trafficable, spade resistant, reduces subsonic noise, non-rotting, compatible with bitumen. Weight: ca. 5 kg/m²; load bearing capacity: 460 kN/m²; total height: ca. 25 mm; stud height: 20 mm; number of studs: > 600/m². The boards can be interconnected with special PD 250-Connectors which can be clipped onto the specially shaped edge studs of the adjacent elements. We recommend one connector per running meter.

	Art. No.	Dimensions	Unit	Pallet
PD 250	3250	ca. 1.00 m × 2.00 m	2.00 m ² board	75 boards
PD 250-Connector	3251		Bag of 200 pieces	

Elastodrain® EL 202

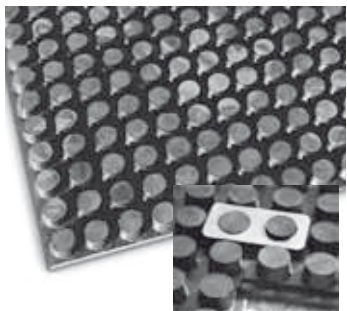

Especially developed for driveways and other build-ups with high load; extremely heavy duty drainage and building protection boards made of fully vulcanized rubber; with rebated edge. Elastodrain® EL 202 is particularly suitable for use under driveways, fire brigade access etc. It is spade resistant; reduces subsonic noise; non-rotting; compatible with bitumen; load bearing capacity at a compression of 10% : ca. 400 kN/m²; shore strength 75 Shore A; static bedding module ca. 285 MN/m³; weight ca. 19 kg/m²; total height ca. 19 mm; stud height ca. 12 mm; number of studs ca. 1200/m². The boards can be interconnected with special EL 202-Connectors. We recommend two connectors per running meter.

	Art. No.	Dimensions	Unit	Pallet
EL 202	3220	ca. 1.00 m × 1.00 m	1.00 m ² board	50 boards
EL 202-Connector 2-holes	3221		Bag of 100 pieces	

Fixodrive® FX 50

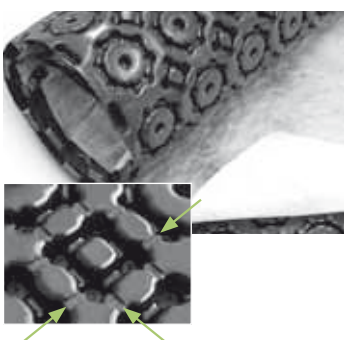

Driveable and quickly installed protection and drainage mat made of thermoformed recycled polyolefin with attached filter sheet of strength class 3 to be used under intensive green roofs as well as driveways and footpaths. With interlocking studs for connection on its long sides and diffusion holes. Also suitable for inverted roofs due to the diffusion openings and underlying connected channels. Colour: grey/white; height: ca. 20 mm, in plane-water flow capacity tested according to European Standard EN ISO 12958, max. compressive strength up to 500 kN/m²; weight: ca. 1.8 kg/m², weight per roll: ca. 23 kg.

	Art. No.	Dimensions	Unit	Pallet
FX 50	3150	ca. 1.00 m × 15.00 m	15 m ² roll	90 m ²

Drainage Elements/Protection Mats

Floraset® Elements contain water storage cells, openings for aeration and diffusion as well as a drainage channel system on the underside. They are especially suited for large green roof areas without slope. In particular Floraset® FS 75 is also used for the System Build-up "Pitched Green Roof" with slopes up to 25°; in this case Floraset® FS 75 Elements are installed with the studs facing upwards. Floraset® Elements are made of expanded polystyrene (EPS) and are free of CFC.

Floraset® FS 50

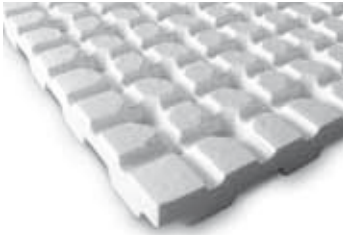

Drainage board for extensive green roofs on flat roofs with and without slope; made of expanded polystyrene (EPS); free of CFC; with water storage cells, openings for aeration and diffusion as well as a continuous channel system on the underside. In-plane water flow rate tested according to European Standard DIN EN ISO 12958. Density: ca. 20 kg/m³; weight: ca. 0.6 kg/m²; height: ca. 50 mm.

	Art. No.	Dimensions	Unit	Pallet
FS 50	3052	ca. 1.00 m × 1.00 m	1.00 m ² board	54 boards

Floraset® FS 75



Drainage board usable on both sides, for extensive and simple intensive green roofs on flat and pitched roofs (slopes up to 25°, if studs face upwards); made of expanded polystyrene (EPS); free of CFCs; with water storage cells, openings for aeration and diffusion as well as a continuous channel system on the underside; drainage capacity in accordance with in-plane water flow rate tested according to European Standard DIN EN ISO 12958. Density: ca. 23 kg/m³; weight: ca. 1.0 kg/m²; height: ca. 75 mm.

	Art. No.	Dimensions	Unit	Pallet
FS 75	3076	ca. 1.00 m × 1.00 m	1.00 m ² board	40 boards

Filter Sheet Pin



Made of polyethylene; for punctual fixing of filter sheets on all drainage elements made of polystyrene hard foam (Floraset®). Ca. 1 Filter Sheet Pin/m² required. Head diameter: ca. 30 mm; pin diameter: ca. 8 mm; length of pin: ca. 34 mm.

	Art. No.	Unit
Filter Sheet Pin	9621	Bag of 100 pieces

Drainage Mat DBV 10



Studded sheet made of recycled polyolefin with attached filter sheet for overlapping lengthwise. Connection of single sheets lengthwise on interlocking studs. Characteristic opening size $O_{90,W}$ 150 μm, total height ca. 10 mm; area weight ca. 850 g/m²; max. load bearing capacity ca. 450 kN/m²; in-plane water flow capacity tested according to EN ISO 12958, delivery and installation according to manufacturer's instructions.

	Art. No.	Dimensions	Unit
DBV 10	3011	ca. 1,04 m × 12,00 m	12,5 m ² roll

Filter Sheets

Only when a seeping layer is covered with a filter sheet does it become a fill-stable drainage layer as required by German Standard DIN 4095 "Drainage for the protection of built structures". On drainage elements such as Floradrain®, Floraset®, etc. the Filter Sheet SF is sufficient, on drainage layers of loose materials (especially where they consist of sharp-edged materials) and in build-ups for driveways. Filter sheets of type TG or PV should be installed with ca. 200 mm overlap. Filter sheets should not be exposed to direct sunlight for a long period of time due to their low-level UV resistance. With CE-marking, for use in drainage layers and many other areas.

Filter Sheet SF



Details on page 40

Thermally strengthened filter sheet made of polypropylene; for normal mechanical stress and strain; applicable as a filter sheet on ZinCo drainage element; non-rotting; water passage $Q = \text{ca. } 70 \text{ l/m}^2 \times s$ at 100 mm water column; effective opening width (O_{90}) according to European Standard EN ISO 12956: ca. $95 \mu\text{m}$; strength class 2; weight: ca. 100 g/m^2 .

	Art. No.	Dimensions	Unit	Pallet
Filter Sheet SF	2100	ca. 2.00 m × 100.00 m	200 m ² roll	4600 m ²
	2102	ca. 1.00 m × 100.00 m	100 m ² roll	2500 m ²
Blank	2101	ca. 2.00 m × 10.00 m	20 m ²	

Filter Sheet TG



Thermally strengthened filter sheet made of polypropylene; for high mechanical stress and strain, can therefore be used particularly as a filter sheet on the drainage element EL 202 and on gravel or stone chippings drainage layers; non-rotting; water passage $Q = \text{ca. } 55 \text{ l/m}^2 \times s$ at 100 mm water column; effective opening width (O_{90}) according to European Standard EN ISO 12956: ca. $70 \mu\text{m}$; strength class 3; weight: ca. 150 g/m^2 .

	Art. No.	Dimensions	Unit	Pallet
Filter Sheet TG	2192	ca. 2.00 m × 100.00 m	200 m ² roll	1800 m ²
	2193	ca. 1.00 m × 100.00 m	100 m ² roll	900 m ²

Filter Sheet PV



Strengthened, extra stiff filter sheet made of polypropylene; for high mechanical stress and strain, therefore applicable in gravel layers or on Elastodrain® drainage elements under walkways and driveways; non-rotting; as protection layer usable where no water retention is desired (e.g. below Aquatec®, under driveways with Stabilodrain® or Fixodrive®). Water passage $Q = \text{ca. } 30 \text{ l/m}^2 \times s$ at 100 mm water column; effective opening width (O_{90}) according to European Standard EN ISO 12956: ca. $60 \mu\text{m}$; strength class 4, weight: ca. 300 g/m^2 .

	Art. No.	Dimensions	Unit	Pallet
Filter Sheet PV	2131	ca. 2.00 m × 50.00 m	100 m ²	900 m ²

Filter sheets in different strength classes and weights available upon request.

Mineral Substrates

Mineral Substrate Zincolit®



The Mineral Substrate Zincolit® is a high quality recycled product based on specially processed clay tiles; stable structure; frost resistant and non-flammable. Zincolit® is especially suited for infilling drainage layers and for creating fireproof zones. It is also suitable for extensive green roofs with multilayer build-ups, particularly for plants belonging to the plant list "Sedum Carpet".

Zincolit®

Please note that ZinCo System Substrates are supplied in Big Bags, as bulk material or in silo.

Substrate Delivery Types



Zincolit®, Zincohüm® and the ZinCo System Substrates are available in various delivery types. Depending on the size and location of the roof and the type of substrate, a choice can be made from one of the following delivery types: bulk material, in Big Bags or in silo. Please don't hesitate to contact us should you require further information about our substrate delivery types.

Considerations before placing an order: Substrates, mainly those with a higher percentage of organic material, are subject to different rates of settlement. To reach the desired final height it is important to apply more substrate. The settlement factors are shown in the table.

Example: Desired final height: 70 mm of system substrate "Rockery Type Plants"

Required order size: $70 \times 1.2 = 84 \text{ l/m}^2$, e.g. 42 m^3 of substrate are necessary for an area of 500 m^2 .

The settlement factor refers to settlement after substrate installation. Please be aware that the substrate weight is quantified after loading. The specific weight of the substrate may change during transport.

Substrate	Settlement-factor	Weight/m ² saturated after settlement
Zincolit®	1.10	ca. 13 kg/cm
System× Substrate "Sedum Carpet"	1.12	ca. 14 kg/cm
System Substrate "Rockery Type Plants"	1.20	ca. 14 kg/cm
System Substrate "Heather with Lavender"	1.25	ca. 15 kg/cm
System Substrate "Roof Garden"	1.30	ca. 15 kg/cm
System Substrate "Lawn"	1.25	ca. 14 kg/cm

ZinCo Turbobag®



The ZinCo Turbobag®, a flexible chute with lockable and regulating outlet hose, is for the application of Zincolit® system substrates "Sedum Carpet" and "Rockery Type Plants" as well as other free flowing bulk material with a maximum grain size of 32 mm. Using this effective method, substrates can be delivered as bulk material at a reasonable price and distributed easily over the roof. Technical data: size 5 m × 5 m; length of outlet hose ca. 3.5 m; max. load capacity: ca. 5000 kg; weight: ca. 60 kg; transport measures of empty bag: ca. 400 mm × 700 mm × 1300 mm.

	Art. No.	Unit
ZinCo Turbobag® for System Substrates, Zincolit®, gravel etc.	15035	Piece
Quad Leg Bridle Sling for ZinCo Turbobag®	15036	Piece

System Substrates

A system substrate that is adapted to meet the requirements of the selected plant community guarantees a durable and species-appropriate development. It is a decisive factor for the long-term functionality of the green roof. ZinCo offers various system substrates for different system build-ups and for different kinds of green roofs. Special customized substrates are also available upon request. The system substrates are produced in accordance with German FLL-Guidelines and are available in various delivery types. We will be happy to provide you with a quotation for your project.

System Substrate "Sedum Carpet"



System Substrate "Sedum Carpet" is particularly suitable for extensive green roofs on single or multi-layer system build-ups in combination with plants belonging to the plant list "Sedum Carpet". The plants are available as plug plants or Sedum cuttings.

Substrate "Sedum Carpet"

Please note that ZinCo System Substrates are supplied in Big Bags, as bulk material or in silo.

System Substrate "Rockery Type Plants"



System Substrate "Rockery Type Plants" is particularly suitable for extensive green roofs on multi-layer system build-ups in combination with plants belonging to the plant list "Rockery Type Plants". The plants are available as plug plants.

Substrate "Rockery Type Plants"

Please note that ZinCo System Substrates are supplied in Big Bags, as bulk material or in silo.

System Substrate "Heather with Lavender"



System Substrate "Heather with Lavender" is particularly suitable for simple intensive green roof build-ups in combination with plants belonging to the plant list "Heather with Lavender". A higher depth of system substrate also allows bushes and small trees to grow.

Substrate "Heather with Lavender"

Please note that ZinCo System Substrates are supplied in Big Bags, as bulk material or in silo.

System Substrate "Roof Garden"



System Substrate "Roof Garden" is particularly suitable for intensive green roof build-ups. Depending on the substrate depth, more demanding plants such as perennials, higher bushes and trees are possible.

Substrate "Roof Garden"

Please note that ZinCo System Substrates are supplied in Big Bags and as bulk material.

System Substrate "Lawn"



System Substrate "Lawn" is a fine grading substrate especially developed for the cultivation of lawn. A greater depth of system substrate also allows for the growth of perennials, bushes and trees.

Substrate "Lawn"

Please note that ZinCo System Substrates are supplied in Big Bags, as bulk material or in silo.



Details on page 40

Substrates in Bags

Zincolit® Plus – Mineral Substrate



Comes in an easy-to-carry 20 litre bag

Zincolit® Plus is manufactured on the basis of Zincolit® and is enriched with other mineral aggregates. Zincolit® Plus has a stable structure and is pH-neutral, frost-proof and non-flammable. It is suitable for filling drainage elements and as a vegetation substrate for extensive green roofs as a single or multi-layer. Bulk density, damp: ca. 1100 g/l; weight: ca. 22 kg/20 l bag.

	Art.-No.	Unit	Pallet
Zincolit® Plus	6030	20 l-bag	60 bags

System Substrate "Rockery Type Plants"



Comes in an easy-to-carry 20 litre bag

This proven standard substrate is best suited for extensive green roofs as a multi-layer solution with sedum types and perennials from the plant community "Rockery Type Plants". Bulk density, damp: ca. 1000 g/l; weight: ca. 20 kg/20 l bag.

	Art.-No.	Unit	Pallet
System Substrate „Rockery Type Plants“	6001	20 l-bag	60 bags

System Substrate "Heather with Lavender"



Comes in an easy-to-carry 20 litre bag

This proven standard substrate is best suited for simple intensive green roofs with plant types from the ZinCo plant community "Heather with Lavender" or with deeper substrate layers for shrubs and trees. The system substrate is ideal for trough plants. Bulk density, damp: ca. 1000 g/l; weight: ca. 20 kg/20 l bag.

	Art.-No.	Unit	Pallet
System Substrate „Heather with Lavender“	6020	20 l-bag	60 bags

Zincohum®



Comes in an easy-to-carry 20 litre bag

Zincohum® is a seed substrate manufactured on the basis of substrate compost and enriched with clay and fibrous materials. Zincohum® is used as an organic component for the manufacture of system substrates and as an organic fertilizer and top soil supplier. It is also used for the seed bed for the "Meadow Scents" and "Country Colours" seed mixtures. Bulk density, damp: ca. 600 g/l; weight: ca. 12 kg/20 l bag.

	Art.-No.	Unit	Pallet
Zincohum®	6053	20 l-bag	60 bags

Fertilizer / Seed Mixtures

Plantfit 4 M



Granulated and compacted slow release fertilizer NPK 23-5-10 with at least 80 % coated particles. Used for extensive and intensive green roofs, post-planting and later on. One application of the slow release fertilizer is sufficient for an entire vegetation period. The recommended period to fertilize is spring.

	Art. No.	Unit
ZinCo Plantfit® 4 M	8550	Container with 2.5 kg
ZinCo Plantfit® 4 M	8551	Container with 10 kg
ZinCo Plantfit® 4 M	8552	Container with 25 kg

Seed Mixtures



Ready-to-sow seed mixture with organic adhesive for dry seeding. All seed mixtures contain high quality plants with long life expectancies. We intentionally avoided plants with tall growth and extreme development of foliage. As the organic adhesive fixes the seed mixture to the ground the substrate should be humid before sowing, thus allowing the adhesive to work instantly. Irrigation after sowing has the same effect. The area should not be walked on after sowing so that the structure of the adhesive is not destroyed. Recommended amount to be spread: min. ca. 25 g/m². On pitched roofs the amount is greater, for example 40 g/m² for a slope of 20°. The seed mixtures can also be used for wet sowing in combination with mulch material and fertilizer. The seed mixtures are delivered in cotton or jute bags of min. 0.5 kg. Storage is possible in a cool and dry place for a short period only. All seed mixtures are suitable with at least 70 mm of System Substrate "Rockery Type Plants". In many cases a combination of Sedum cuttings and a seed mixture is recommended (e.g. 30 g of Sedum cuttings/m² and 15 g Seed Mixture).

Available seed mixtures:

	Art. No.	Unit
Seed Mixture "Meadow Scent" plant list see below	8003	0.5 kg bag
	8004	1.0 kg bag
	8005	2.0 kg bag
	8006	5.0 kg bag
Seed Mixture "Grassy Pasture" plant list see below	8023	0.5 kg bag
	8024	1.0 kg bag
	8025	2.0 kg bag
	8026	5.0 kg bag
Seed Mixture "Country Colours" plant list see below	8013	0.5 kg bag
	8014	1.0 kg bag
	8015	2.0 kg bag
	8016	5.0 kg bag

Plant List "Meadow Scent"

Seed mixture containing more than 25 different herbs – no grasses! For example, *Dianthus carthusianorum*, *Helianthemum nummularium*, *Hieracium pilosella*, *Petrorhagia saxifraga*, *Potentilla neumanniana*, *Prunella grandiflora* and *Thymus serpyllum*.

Plant List "Grassy Pasture"

Seed mixture containing more than 8 different grasses with a low foliage development. Main varieties: regional *Festuca ovina* and other *Festuca* and *Carex* varieties. This seed mixture can be installed without Sedum cuttings. It is characterised as being highly drought resistant and is especially capable of regeneration.

Plant List "Country Colours"

Seed mixture containing 60 % seed mixture "Grassy Pasture" and 40 % seed mixture "Meadow Scent".

Pitched Green Roofs

Floraset® FS 75



Floraset® FS 75 is the core piece of the System Build-up "Pitched Green Roof". It can be used for pitched roofs with slopes up to 25°. FS 75 elements are made of expanded polystyrene (EPS); studs facing upwards interlocking with the substrate; drainage channel system on the underside; weight: ca. 1.0 kg/m²; height: ca. 75 mm, filling volume (when installed with studs facing upwards): ca. 20 l/m².

	Art. No.	Dimensions	Unit	Pallet
Floraset® FS 75	3076	ca. 1.00 m × 1.00 m	1.00 m ² board	40 boards

Jute Anti-Erosion Net JEG

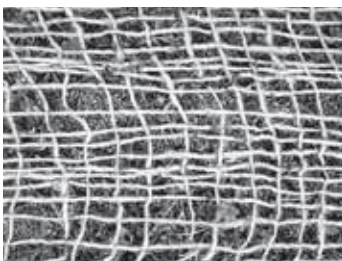

Coarse meshed net made of 100 % jute, to protect newly installed green roofs from wind and water erosion; jute is 100 % biologically degradable; used on pitched green roofs, banks, shores etc. For environmental reasons, the Jute Anti-Erosion Net is not flame retardant and therefore has to be protected from fire and embers. Weight: ca. 500 g/m²; mesh size: ca. 30–40 mm.

	Art. No.	Dimensions	Unit	Pallet
Jute Anti-Erosion Net JEG	2856	ca. 1.22 m × 70.00 m	85.4 m ² roll	683.2 m ²

Shear Fix LF 300



Shear-retaining bracket made of solid stainless steel 5 mm × 50 mm for use on water-proofed, sloped roof areas to prevent the green roof build-up from slipping. It is installed at the eaves or as a shear barrier within the surface, in combination with eaves profile TRP 80 or TRP 140. The bracket is mounted onto the supporting structure using 5 corrosion resistant screws and is waterproofed, as per the loose-fixed flange system in line with the requirements of German Standard DIN 18195-9, with the waterproofing materials used for the building. Length: ca. 400 mm, height: retaining bracket ca. 100 mm, weight: ca. 1.8 kg including screws, load capacity: max. 300 kg/bracket.

Approved materials for fastening to concrete are available upon request.

Scope of delivery: 1 base plate, 1 bracket, 2 nuts M10 (all stainless steel), 5 wood screws (galvanised steel), 1 bit, 2 interim layers of EPDM (1 large + 1 small)

	Art. No.	Unit
Shear Fix LF 300	9568	Piece

Eaves Profile TRP 140



Eaves Profile TRP 140, bend-proof angle profile made of stainless steel; for finishing eaves on pitched green roofs; ideal in combination with support brackets; with drainage slots and welded joint connectors. Height of vertical leg: 140 mm.

	Art. No.	Dimensions	Unit
Eaves Profile TRP 140	7782	Length 3 m	Piece

Steep Pitched Green Roofs

Georaster®

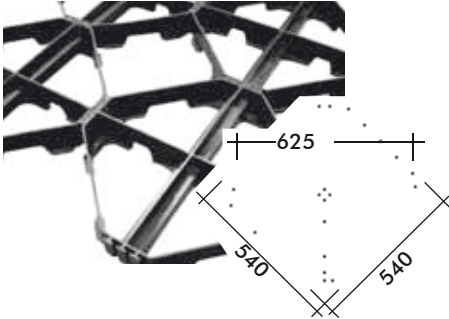

Georaster® elements are used for the system build-up "Steep Pitched Green Roofs" with a slope of 20° to 35°. The Georaster® elements are made of polyethylene (HD-PE). They contain a reinforced centre bar to bear the shear forces. An integrated T-plug connection locks the elements together. Georaster® can also be used for reinforcement of gravel turf, for building driveways on a smooth/soft subgrade or as slope protection. Height: ca. 100 mm; weight ca. 2.1 kg/piece; grid dimension 625 mm; requirement of 2.56 elements/m².

	Art. No.	Dimensions	Unit	Pallet
Georaster®	3400	ca. 540 mm × 540 mm	Piece	96 pieces

Snow Guard Support SFH and Snow Guard Grid SFG

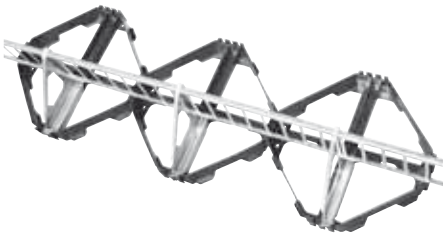

The snow guard support can be mounted on the Georaster® elements without using a tool. They comprise a support and a snow guard grid to catch the snow. The aluminium supports are available in a left and right version. The snow guard grid, made of galvanized steel plate, is ca. 3 m long and is delivered together with two connectors.

	Art. No.	Dimensions	Unit
Snow Guard Support SFH right	9570	Height ca. 250 mm	Piece
Snow Guard Support SFH left	9571	Height ca. 250 mm	Piece
Snow Guard Grid SFG	7772	Height ca. 200 mm	Piece

Inspection Chamber for Pitched Roofs SKS 12



Inspection chamber made of galvanised and plastic-coated steel; triangular form without flange; for use on steep pitched roofs in connection with Georaster® elements; to be installed over the water outlet. Weight: ca. 1,5 kg; Outer dimension of the chamber: ca. 240 mm × 240 mm × 330 mm; Aperture dimension: ca. 200 mm × 200 mm × 280 mm.

	Art. No.	Height	Unit
SKS 12	4298	ca. 120 mm	Piece

Support Brackets TSH 80 / 100 and Eaves Profile TRP 140



Support Bracket: Made of solid stainless steel; with sandblasted, matt finish; ideal for use in connection with Eaves Profiles TRP 80 or TRP 140 for the bearing of shear forces on green roofs with slopes of min. 10°. To be fixed directly into the rafters.

Type "TSH 80": Made of flat steel 5 mm × 40 mm; height of front upstand ca. 80 mm; leg length ca. 400 mm; fixed using three 8 mm screws; can bear up to 150 kg/support bracket.

Type "TSH 100": Made of flat steel 5 mm × 50 mm; height of front upstand ca. 100 mm; leg length ca. 400 mm; fixed using four 8 mm screws; can bear up to 300 kg/support bracket.

Eaves Profile TRP 140, bend-proof angle profile made of stainless steel; for finishing eaves on pitched green roofs; ideal in combination with support brackets; with drainage slots and welded joint connectors. Height of vertical leg: 140 mm.

	Art. No.	Dimensions	Unit
Support Brackets TSH 80	9563		Piece
Support Brackets TSH 100	9565		Piece
Eaves Profile TRP 140	7782	Length 3 m	Piece

System Build-up "Summer Plains"

The System Build-up "Summer Plains" is a simple intensive green roof. The combination of the patented products Aquatec® and the Wicking Mat provides a plant adapted, water-saving capillary irrigation. On the System Substrat „Lawn" a simple intensive vegetation, for example shrubs, lawns or similar can be applied. The dripperlines can be clipped into the division bars of the Aquatec® elements. The Irrigation Manager BM 4 controls the irrigation, supplying up to 1000 m² of roof area. In addition, you only need standard water pipes (diameter 32 mm) and connection accessories. The standard accessories .required are available from ZinCo, please ask for an object-specific quotation.

Aquatec® AT 45

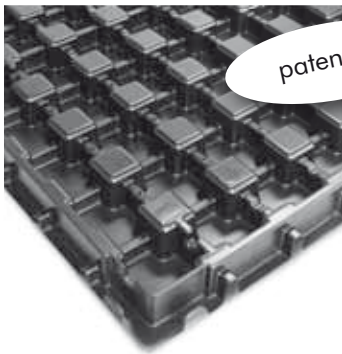

Water distribution, storage and drainage element made of thermoformed recycled hard plastic; ABS; especially developed to be used in connection with a special dripperline and the Wicking Mat DV 40. The basic principle is the distribution and storage of water in the cells of the elements. The water will be transported through the Wicking Mat DV 40 upwards by capillarity when needed. The water supply takes place via special dripperlines. These can be clipped without any tools into the division bars of the elements. The elements can be connected via special studs along one of the long and narrow sides. Material: ABS, colour: black; height: 45 mm, weight: 2.0 kg/m², water storage volume in the troughs: about 17 l/m².

	Art. No.	Dimensions	Unit	Pallet
Aquatec® AT 45	3345	ca. 1.02 m × 2.02 m (net 1.00 m × 2.00 m)	2.00 m ² board	135 boards

Wicking Mat DV 40



Water distributing polyester fleece with capillary-effective fibres on one side, especially developed for the use in combination with the water distribution, storage and drainage element Aquatec® AT 45. Material: polyester; colour: white (mat)/grey (fibres); weight: ca. 600 g/m², fibre length: ca. 400 mm.

	Art. No.	Dimensions	Unit
Wicking Mat DV 40	2160	ca. 2.00 m × 25.00 m	50 m ² roll
	2165	ca. 2.00 m × 10.00 m	20 m ² roll
Roll width ca. 2.10 m including ca. 100 mm fibre-free edge on one side for overlapping.			

Dripperline 100-L1

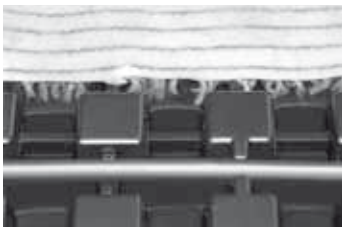

Dripperline for the irrigation of green roofs in combination with the water distribution, storage and drainage element Aquatec® AT 45 and the Wicking Mat DV 40. Outer diameter: ca. 16 mm, with inside placed drippers, dripper spacings 100 mm, dripper capacity ca. 1 l/h, pressure-compensating.

	Art. No.	Dimensions	Unit	Pallet
Dripperline 100-L1	9310	Ø ca. 16 mm	100 m roll	24 rolls

Irrigation-Manager BM 4



Pre-assembled programming unit for outdoor use for automated irrigation of green roofs; lockable stainless steel box incl. connection for water supply pipe 32 mm, filter, pressure regulator, water tap connection, irrigation time controller, (operated via batteries, therefore no power supply required), 4 magnetic valves 1" including connectors for 32 mm tube and rain sensor. weight: ca. 14 kg; Required water pressure: min. 1,5 bar.

	Art. No.	Dimensions
Irrigation-Manager BM	44045	L × W × H: ca. 580 mm × 390 mm × 250 mm

Inspection Chambers

Green roofs must be drained safely and constantly. A basic requirement for proper drainage is accessibility to the roof outlets at all times for checking and cleaning purposes. Therefore, an inspection chamber is installed over each roof outlet. The chamber height can be adjusted to match the system build-up height.

Inspection Chamber KS 6 / KS 10 / Extension Pieces



Inspection chambers made of plastic-coated aluminium; for installation onto the drainage elements or within the substrate layer; with steel cover resistant to compression; fits all drain outlet sizes. The inspection chambers can also be supplied with a lock. Combined with an KSA extension piece, the inspection chambers can be used for higher build-ups. Outer dimension: ca. 300 mm × 300 mm, with extended flange: ca. 530 mm × 300 mm; aperture dimension: 240 mm × 240 mm.

	Art. No.	Height	Unit
Inspection Chamber KS 6 (weight: 2,6 kg)	4006	ca. 60 mm	Piece
Inspection Chamber KS 10 (weight: 2,8 kg)	4010	ca. 100 mm	Piece
Extension Piece KSA 8 (weight: 1,0 kg)	4008	ca. 80 mm	Piece
Extension Piece KSA 20 (weight: 2,0 kg)	4020	ca. 200 mm	Piece
Locking set	9031		

Inspection chambers made of stainless steel are available upon request.

Patent pending



Pull out flange - inside the chamber for easy transportation and storage

Pull out flange - pulled out prior to installation

Low transport volume, yet fixed positioning achieved by superimposed load when installed.

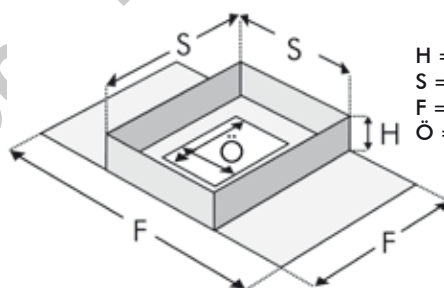

H = Height
S = Dimension
F = Flange
Ö = Aperture dimension

Inspection Chamber AKS 8



Made of galvanized and plastic coated steel; with one open side and three flanged sides, developed for water outlets near parapets or water spouts, can be used on upstands with insulation material fillet, perforated edges to install without tools. Removable lid, walkable with thermally insulating material and water openings according to German Standard FLL-Green Roof Guideline; can be combined with the Extension Pieces KSA 8 and KSA 20. Height: ca. 80 mm; aperture dimension: ca. 240 mm × 240 mm; flange: ca. 300 mm × 300 mm; slots: ca. 3mm; colour: old silver-antique; flange on three sides ca. 85 mm.

	Art.-Nr.	Height	Unit
Inspection Chamber AKS 8 (weight: 2,9 kg)	4007	ca. 80 mm	Piece
Extension Piece KSA 8 (weight: 1,0 kg)	4008	ca. 80 mm	Piece
Extension Piece KSA 20 (weight: 2,0 kg)	4020	ca. 200 mm	Piece
Locking set	9031		

Inspection Chambers

Inspection Chamber for Pitched Roofs SKS 12



Inspection chamber made of galvanised and plastic-coated steel; triangular form without flange; for use on steep pitched roofs in connection with Georaster® elements; to be installed over the water outlet. Weight: ca. 1,5 kg; dimensions: 240 mm × 240 mm × 330 mm; aperture dimension: 200 mm × 200 mm × 280 mm.

	Art. No.	Height	Unit
Steep Pitchen Roof Inspection Chamber SKS 12	4298	ca. 120 mm	Piece

Inspection Chamber KS 30, stainless steel / fillable cover / Extension Piece



High quality inspection chamber made of stainless steel; with lateral drainage slots; with lockable and walkable cover with openings for water; vertically adjustable membrane collar for continuous installation of the filter sheet. Colour: stainless steel; weight: ca. 4.0 kg; dimensions: ca. 300 mm × 300 mm; aperture dimension: ca. 240 mm × 240 mm.

	Art. No.	Height	Unit
Inspection Chamber KS 30, stainless steel (with stainless steel lid)	4035	ca. 300 mm	Piece
Inspection Chamber KS 30-B, stainless steel (lid may be filled with gravel)	4038	ca. 360 mm	Piece
Extension Piece KSA 15-E stainless steel (weight: ca. 1.8 kg)	4036	ca. 150 mm	Piece

Inspection Chamber KS 52

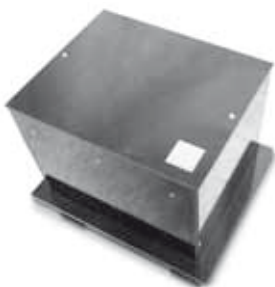

Inspection chamber made of polyethylene; solid design; with lockable cover; with load distributing support footing; bigger than KS 30 with lateral all-round reinforcing flange for continuous installation of the filter sheet. Weight: ca. 13.5 kg; dimensions: ca. 400 mm × 500 mm; aperture dimension: ca. 380 mm × 480 mm.

	Art. No.	Height	Unit
Inspection Chamber KS 52	4060	ca. 520 mm	Piece

Available in project specific sizes. Extension pieces available upon request.

Irrigation Units / Accessories

Challenging roof gardens can be irrigated within the drainage layer using a water dam-up system over the waterproofing layer (on 0°-Roofs only). The irrigation unit regulates the level of dammed water. ZinCo Irrigation Units use a mechanical swimmer-control unit. For ecological reasons, rainwater, e.g. collected in a tank or subsurface cistern should be used for irrigation. However, potable water can also be used.

Irrigation Unit B 32



Irrigation unit made of durable polyethylene; solid design; lockable cover; mechanical swimmer-control; valve in accordance with European Standard EN 1717 to be provided by the customer. If necessary, the Irrigation Unit B 32 is available with vertically adjustable membrane collar for continuous installation of the filter sheet (see page 22, KS 30). Colour: black; connection 1/2" – tube or hose pipeline; weight: ca. 7 kg; dimensions: ca. 300 mm × 300 mm; aperture dimension: ca. 270 mm × 270 mm.

	Art. No.	Height	Unit
Irrigation Unit B 32	4031	ca. 320 mm	Piece
Extension Piece KSA 15-PE (weight: ca. 2.2 kg)	4016	ca. 150 mm	Piece

The B 32 is available in stainless steel upon request.

Irrigation Unit KB 52



Like Irrigation Unit B 32 but larger. It can be used as an inspection chamber at the same time, with lateral all-round reinforcing flange. Weight: ca. 15 kg; size: ca. 400 mm × 500 mm; aperture dimension: ca. 380 mm × 480 mm.

	Art. No.	Height	Unit
Irrigation Unit KB 52	4061	ca. 520 mm	Piece

Optional additional hose connection for manual irrigation.

Roof Dam Element copper / PE



Roof Dam Element copper: To create water dam-up over the waterproofing for long-term irrigation, mainly used on intensive green roofs. Made of copper with adhesive flange and detachable extension piece, including sealing ring. To be glued into bituminous waterproofing; extension piece for water dam-up level of ca. 40 mm. Extension piece for other water levels are available upon request. Diameter of opening ca. 90 mm; weight ca. 1.0 kg.

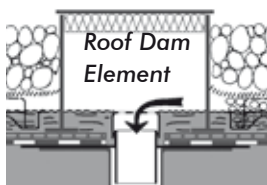

Roof Dam Element PE: Like the roof dam element copper, but with flange made of polyethylene to be included into waterproofing membranes or root barriers made of FPO (e.g. root barrier WSB 100-PO). Aperture diameter ca. 90 mm; weight ca. 0.5 kg.

	Art. No.	Unit
Roof Dam Element copper	4140	Piece
Roof Dam Element PE	4142	Piece

Drainage Channels

Drainage Channels FR – galvanized steel and plastic-coated

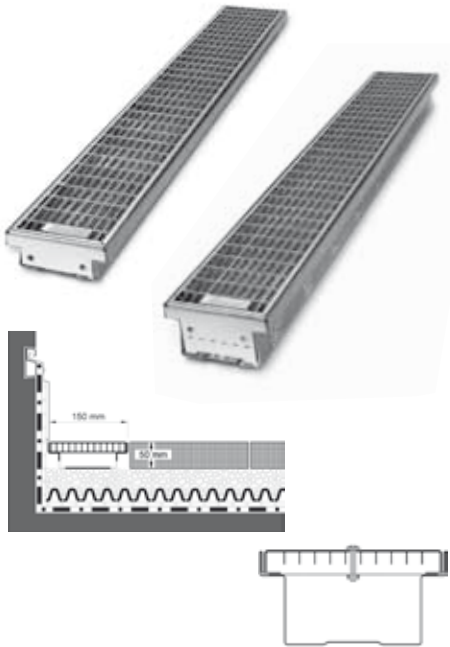

Solid, plastic-coated and galvanized channel with walkable grill, can be screwed together at the joints; ensures efficient water drain-off in front of facades and areas with a higher water accumulation; allows for reduced connection height around thresholds and on terraces (special solution in accordance with Standard DIN and FLL). If necessary, the endings can be turned inwards manually (only FS 75). Grill mesh width: ca. 33 mm × 11 mm; width: ca. 150 mm.

	Art. No.	Height	Unit
FR 50-1 (length ca. 1.00 m; weight: ca. 4.7 kg)	4741	ca. 50 mm	Piece
FR 75-1 (length ca. 1.00 m; weight: ca. 5.0 kg)	4751	ca. 75 mm	Piece
FR 50-2 (length ca. 2.00 m; weight: ca. 9.2 kg)	4742	ca. 50 mm	Piece
FR 75-2 (length ca. 2.00 m; weight: ca. 9.8 kg)	4752	ca. 75 mm	Piece
FR 50-3 (length ca. 3.00 m; weight: ca. 14.0 kg)	4743	ca. 50 mm	Piece
FR 75-3 (length ca. 3.00 m; weight: ca. 14.3 kg)	4753	ca. 75 mm	Piece
90°-Corner for FR 50-G1, G2, G3; (weight: ca. 4.0 kg)	4745	ca. 50 mm	Piece
90°-Corner for FR 75-G1, G2, G3; (weight: ca. 4.3 kg)	4755	ca. 75 mm	Piece
Leg length ca. 500 × 500 mm each			
Screw Kit for connecting the Drainage Channels	9130		Piece
Screw kit for locking the "grill" to Drainage Channel FR	9135		Piece

Drainage Channel FTR – Aluminium



From above adjustable aluminum drainage channel; cover with oblong hole slots: 30 mm × 8 mm or with galvanized grating; Grill mesh width: 33 mm × 11 mm. The channel ensures the rapid dispersal of rainwater flowing from the facade and allows low connection structures in the door and terrace area. Channel body and side slits; slit width of about 3 mm; with integrated bumper connector which may also serve as an ending when folded up.

	Art. No.	Dimension	Unit
FTR – 55/75 A (cover made of aluminium adjustable 55–75 mm; weight: ca. 2.5 kg)	4747	ca. l: 1,00 m, w: 145 mm	Piece
FTR – 75/100 A (cover made of aluminium adjustable 75–100 mm; weight: ca. 2.7 kg)	4757	ca. l: 1,00 m, w: 145 mm	Piece
FTR – 55/75 Eck, 90°-corner (cover made of aluminium; weight: ca. 1.1 kg; leg length outside: ca. 250 mm × 250 mm)	4749	ca. l: 0,25 m, w: 145 mm	Piece
FTR – 75/100 Eck, 90°-Eckstück (cover made of aluminium; weight: ca. 1,2 kg; leg length outside: ca. 250 mm × 250 mm)	4759	ca. l: 0,25 m, w: 145 mm	Piece
FTR – 55/75 G (with galvanized grate adjustable 55–75 mm; weight: ca. 5,5 kg)	4748	ca. l: 1,00 m, w: 145 mm	Piece
FTR – 75/100 G (with galvanized grate adjustable 75–100 mm; weight: ca. 5,7 kg)	4758	ca. l: 1,00 m, w: 145 mm	Piece

Drainage Channels

Drainage Channel FR – Vario



As on the left but adjustable in length due to telescopic channel body. The grill can be cut to the required length; the cut edge has to be protected from corrosion. Available in dimensions: 600–1000 mm and 1150–2000 mm; height 50 mm; weight: 5.4 kg and 10 kg.

	Art. No.	Height	Unit
FR 50 – Vario 100 (horizontally adjustable from 600 to 1000 mm)	4746	ca. 50 mm	Piece
FR 50 – Vario 200 (horizontally adjustable from 1150 to 2000 mm)	4744	ca. 50 mm	Piece
Galvanizing Spray (400 ml)	9540		Piece

Balcony and Terrace Channel / System Gutter

Balcony and Terrace Channel BTR – Stainless Steel



Vertically adjustable channel made of premium stainless steel; grill with oblong hole slots, channel body slotted underneath and on the sides; includes connectors and integrated grill locking mechanism. Channel with ca. 100 mm; vertically adjustable from ca. 40–55 mm.

	Art. No.	Length	Unit
Balcony and Terrace Channel BTR (weight: 3.6 kg)	4771	ca. 1.00 m	Piece
90°-Corner for BTR (weight: 1.2 kg)	4775	ca. 220 mm × 220 mm	Piece

System Gutter SR 50 / SR 75



Galvanized steel gutter with anthracite-grey plastic coating and hinged, slotted lid; gutter body with drainage slots. ZinCo System Gutters provide for quick and safe drainage e.g. in front of facades where higher amounts of rainwater are expected. SR 75 can be used ideally as linear drainage in all single and multi-layer extensive green roofs. Delivery with 1 butt joint for each gutter; gutter width: ca. 125 mm; weight: ca. 4,3 – 4,6 kg.

	Art. No.	Height	Unit
SR 50, weight 4.3 kg, length ca. 1.50 m	4251	ca. 50 mm	Piece
SR 75, weight 4.8 kg, length ca. 1.50 m	4271	ca. 75 mm	Piece

Collecting Inspection Chamber

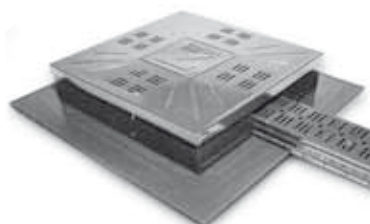

Made of galvanized and plastic coated steel, for the installation above roof outlets (also above fixed gravel retainers); special openings for potential System Gutter insertion; the lateral slots hold back substrate particles but drain the water unhindered (slotted cross section for drainage ca. 380 cm²). The light-proof construction prevents plant growth in the water outlets. Outer dimension: ca. 500 mm × 500 mm; flange: ca. 700 mm × 700 mm; weight: ca. 6.5 kg; aperture dimension: ca. 470 mm × 470 mm.

	Art. No.	Height	Unit
Collecting Inspection Chamber	4211	ca. 110 mm	Piece

Terrace Grills

Terrace Grill – vertically adjustable



Vertically adjustable drainage grill made of galvanized steel with coated gravel retainer frame. The rough height adjustment is done by selecting the corresponding gravel retainer frame; if necessary in combination with the 60 mm tall stacking element; the fine adjustment with a screwdriver from above, without removing the grill. In this way, the height-adjustable terrace grill 40 cm × 40 cm is suitable for mounting heights from 65 mm to 185 mm. For direct installation in paving over the water outlet; Grill mesh width: ca. 33 mm × 12 mm.



	Art. No.	Outer Dimensions	Aperture dimension: Height		Unit
TR-H 40 × 40 – 65	4404	ca. 400 mm × 400 mm	ca. 340 × 340 mm	65 – 95 mm	Piece
TR-H 40 × 40 – 95	4409	ca. 400 mm × 400 mm	ca. 340 × 340 mm	95 – 125 mm	Piece
Extension piece:					
TR-H 40 × 40	4412	ca. 400 mm × 400 mm	ca. 340 × 340 mm	60 mm	Piece
TR-H 40 × 20 – 65	4402	ca. 400 mm × 200 mm	ca. 340 × 140 mm	65 – 95 mm	Piece
TR-H 50 × 50 – 65	4405	ca. 500 mm × 500 mm	ca. 440 × 440 mm	65 – 95 mm	Piece

Inspection Chamber BES / Extension Piece

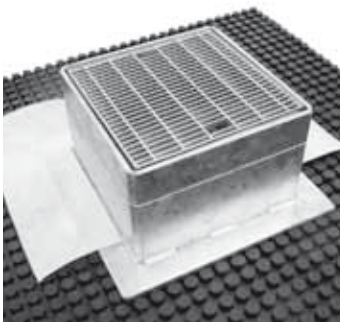

Trafficable inspection chamber made of galvanized steel; dimensions: ca. 300 mm × 300 mm; dimensions with flange: ca. 400 mm × 400 mm; with lockable grill; mesh width: ca. 11 mm × 41 mm; sand trap made of aluminium; with load distributing flange; weight: ca. 30 kg; aperture: ca. 200 mm × 200 mm.

	Art. No.	Height	Unit
BES 125 (weight: ca. 26,0 kg)	4812	ca. 125 mm	Piece
BES 200 (weight: ca. 32,0 kg)	4820	ca. 200 mm	Piece
BES 300 (weight: ca. 39,0 kg)	4830	ca. 300 mm	Piece
Extension Piece for BES (weight: ca. 8,0 kg)	4825	ca. 25 mm	Piece
EL 202-Support Board for BES	3225	ca. 20 mm	Piece

Separations / Eaves Profiles

Concrete Kerb



Concrete Kerb

For edging plant areas, bordering pathways and terraces or for building troughs etc.
Leg length: 250 mm × 300 mm; reversible; length 500 mm; weight: ca. 27.5 kg only

Internal Corner

Two angular stones bevelled to an angle of 45°; to create a 90° internal angle.
Leg length: ca. 480 mm × 480 mm; weight: ca. 46–48 kg

External Corner

Two angular stones bevelled to an angle of 45°; to create a 90° external angle. Leg length: ca. 230 mm × 230 mm; weight: ca. 33–35 kg.

	Art. No.	Dimensions	Unit	Pallet
Congrete Kerb	5025	ca. 500 mm × 300 mm × 250 mm	Piece	40 pieces
Internal Corner	5028	H: ca. 250 mm	Piece	10 pieces
	5030	H: ca. 300 mm	Piece	10 pieces
External Corner	5029	H: ca. 250 mm	Piece	10 pieces
	5031	H: ca. 300 mm	Piece	10 pieces

Eaves Profiles

Eaves Profile TRP 80 / TRP 140



Heavy-duty angle profile made of stainless steel for the edge of walkways or as shear barrier in pitched green roofs (in combination with support brackets). Also to be used as edging in case of missing upstands. Slots in vertical leg for drainage, perforation in support leg for fixing purposes. Includes butt joints. Leg length 80 mm and 140 mm; length each ca. 3 m.

	Art. No.	Dimensions	Unit
TRP 80	7780	L: 3.00 m, H: 80 mm	Piece
TRP 140	7782	L: 3.00 m, H: 140 mm	Piece

Eaves Profiles

Eaves Profiles DP 55 / DP 80 / DP 120



Angle profile made of metal; it is used for bordering green areas, as a gravel retainer or where there is no upstand at the eaves or roof edge. Continuous perforation of the support leg allows for fixation to the waterproofing. Slot perforation for water drainage of ca. 8.500 mm²/m. Length: ca. 3 m. Suitable connectors made of aluminium for professional joint connection of the eaves profiles (butt joint: ca. 5 mm). Suitable external corners in various profile heights; leg length: ca. 250 mm × 250 mm.

A = Aluminium, E = Stainless Steel

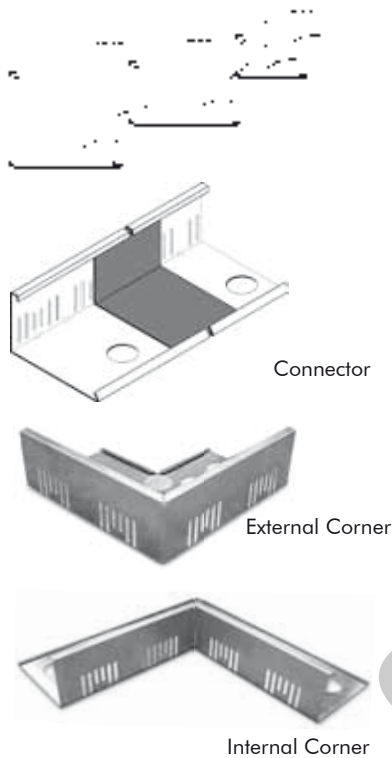

	Art. No.	Height	Unit
DP 55-A	7777	ca. 55 mm	Bundle of 10 pieces (30 m)
DP 55-E	7779	ca. 55 mm	Bundle of 10 pieces (30 m)
External Corner DP 55-A	7792	ca. 55 mm	Piece
External Corner DP 55-E	7793	ca. 55 mm	Piece
Internal Corner DP 55-A	7707	ca. 55 mm	Piece
Connector for DP 55	7778	ca. 55 mm	Piece
DP 80 A Aluminium	7781	ca. 80 mm	Bundle of 10 pieces (30 m)
DP 80 E Edelstahl	7784	ca. 80 mm	Bundle of 10 pieces (30 m)
External Corner DP 80-A	7794	ca. 80 mm	Piece
External Corner DP 80-E	7795	ca. 80 mm	Piece
Internal Corner DP 80-A	7710	ca. 80 mm	Piece
Connector for DP 80	7783	ca. 80 mm	Piece
DP 120-A	7785	ca. 120 mm	Bundle of 10 pieces (30 m)
DP 120-E	7788	ca. 120 mm	Bundle of 10 pieces (30 m)
External Corner DP 120-A	7796	ca. 120 mm	Piece
External Corner DP 120-E	7797	ca. 120 mm	Piece
Internal Corner DP 120-A	7714	ca. 120 mm	Piece
Connector for DP 120	7787	ca. 120 mm	Piece

DP-Fix



The ideal way to fix DP profiles without penetrating the roof waterproofing. The DP-Fix aluminium support is delivered with a pre-slotted fixing mat 750 mm × 500 mm. DP-Fix is a butt joint connector which ensures an even appearance. On roofs with a slope of up to 5°, it can be used as edging board, to border green areas, to retain gravel or as intersectional piece (between gravel, greenery and paved areas). Also available in stainless steel upon request.

	Art. No.	Height	Unit
DP-FIX 55, incl. fixing mat	7705	55 mm	Piece
DP-FIX 80, incl. fixing mat	7708	80 mm	Piece
DP-FIX 120, incl. fixing mat	7712	120 mm	Piece

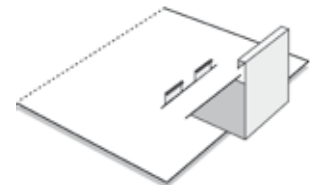
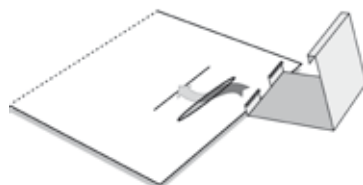

Gravel Retainer / Separation Profile

For clear separation e.g. between substrate and gravel strips we offer gravel retainers and separation profiles. Due to production by extrusion the new gravel bars are very stable. They can also be used on both sides, so that you can service two heights with one product. And because of the profile length of 2 m, the gravel retainers are easy to transport, store and process.

Gravel Retainer KL 60/80 Gravel Retainer KL 100/120

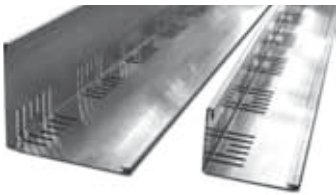

Creation of an external angle with angle connector

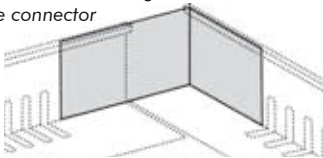

Creation of an internal angle with angle connector

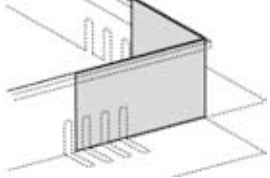

Angle profiles made of natural aluminium for the separation of different build-ups, e.g. gravel strip and vegetated area, strips of Zincolit® or similar.

Gravel Retainer KL 60/80: Material thickness: ca. 1,5 mm; length: ca. 2,0 m; weight: ca. 1,1 kg/piece

Gravel Retainer KL 100/120: Material thickness: ca. 1,8 mm, length: ca. 2,0 m; weight: ca. 2,1 kg/piece

	Art. No	Height	Unit
KL 60/80	7760	ca. 60/80 mm	Bundle of 15 pieces (30 m)
Connector for KL 60/80	7907	ca. 60/80 mm	15 pieces
Angle connector for 60 mm	7916	60 mm	10 pieces
Angle connector for 80 mm	7917	80 mm	10 pieces
KL 100/120	7765	ca. 100/120 mm	Bundle of 10 pieces (20 m)
Connector für KL 100/120	7911	ca. 100/120 mm	10 pieces
Angle connector for 100 mm	7918	100 mm	10 pieces
Angle connector for 120mm	7919	120 mm	10 pieces

Prefabricated welded angles available upon request.

Gravel Retainer KL 55 / KL 85



Angular aluminium profile with rectangular perforations for retaining gravel or for edging gravel strips. Support leg ca. 80 mm, length: ca. 3 m.

	Art. No.	Height	Unit
KL 55	7750	ca. 55 mm	Bundle of 10 pieces (30 m)
Connector for KL 55	7751	ca. 55 mm	Piece
KL 85	7766	ca. 85 mm	Bundle of 10 pieces (30 m)
Connector for KL 85	7768	ca. 85 mm	Piece

Separation Profile TP 75



Profile made of aluminium with drainage slots and alternating support legs (for bending in situ). Enhanced stability and visually appealing due to visible bending edge. The profile is supplied in a space-saving flat-pack; includes joint connectors. Material thickness: 1.0 mm; length: ca. 2 m; profile height: ca. 75 mm; width support leg 30 mm each (alternating left and right, or as required).

	Art.Nr.	Length	Unit
TP 75	7975	2.00 m	Piece

Clamping and Protection Profile

The waterproofing needs to be taken up at any connections and needs to be protected against slipping with clamping profiles. This applies in particular for wall connections. The minimum height of these profiles depends on local regulations in building and constructions. The upper end of these protective profiles needs to be waterproof. Clamping profiles applied in this field need to be resistant against bending; the distance between the single fastening devices shall not exceed 200 mm.

Clamping Profile AP 40



Clamping profile, e.g. for fixation of root barriers, or pond liners to concrete kerbs or planters, made of aluminium; pre-drilled holes, spacing between the holes: ca. 200 mm. Profile height: ca. 40 mm.

	Art. No.	Length	Unit
AP 40	7620	ca. 3.00 m	Bundle of 10 pieces (30 m)

Clamping Profile AP 60

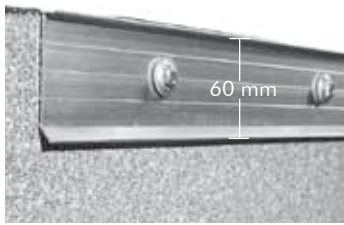

Clamping profile, for fixation of root barriers, plastic and bituminous waterproofings, made of aluminium; pre-drilled holes, spacing between the holes: ca. 200 mm. Profile height: ca. 60 mm.

	Art. No.	Length	Unit
AP 60	7625	ca. 3.00 m	Bundle of 20 pieces (60 m)
AP 60 Internal Corner	7626	ca. 0.25 m × 0.25 m	Piece
AP 60 External Corner	7627	ca. 0.25 m × 0.25 m	Piece
AP 60 Butt joint connector	7628		Piece

Clamping and Protection Profile AP 150

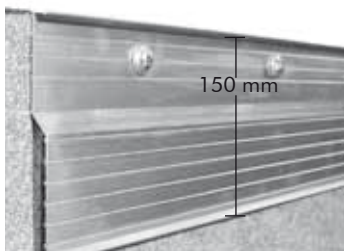

Bending resistant clamping and protection profile made of extruded aluminium, for plastic and bituminous waterproofings, with cover for the protection layer, pre-drilled holes, spacing between holes: ca. 200 mm. Profile height: ca. 150 mm.

	Art. No.	Length	Unit
AP 150	7640	ca. 3.00 m	Bundle of 20 pieces (60 m)
AP 150 Internal Corner	7641	ca. 0.25 m × 0.25 m	Piece
AP 150 External Corner	7642	ca. 0.25 m × 0.25 m	Piece
AP 150 Butt joint connector	7643		Piece



On request also available as bended profile in higher version.

Fall Protection

When working on roof areas, which also includes the maintenance of green roofs, the use of personal safety equipment to prevent from falling off the roof is a requirement at heights of over 3 m (regulated in accident prevention legislation and specific DIN standards). As the inventor of (roof) **non-penetrating fall prevention equipment**, we can provide you with a comprehensive range of safety equipment with our Fallnet® system suitable for all building-specific situations on your roof. The various types of safety equipment can be installed without penetrating the roof membrane, from the single fixing point device to the rail solution and the Guardrail system.

Fallnet® SR – Fixing device – Single point

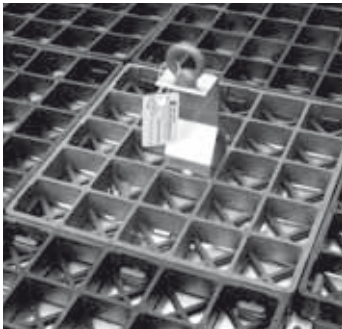

Fixing device for fall protection without roof penetration, tested and certified to European Standard EN 795, Class E. It consists of single grid elements which are plugged together to a unit and covered with at least 90 kg/m² of superimposed load (e.g. ZinCo System Substrate, gravel or comparable bulk material). The fixing point with ring eye is situated centrally in the unit.

Grid elements made of RC polyethylene, height: ca. 30 mm, dimensions: ca. 2.00 m × 2.67 m (delivery in grid segments of 1.00 m × 1.33 m).

Fixing point with ring eye: Support and fixing eye made of stainless steel, height ca. 200 mm, base plate made of aluminium, ca. 750 mm × 750 mm. Fallnet® SR offers the following system advantages: little space required (5.3 m²), therefore suitable for small or narrow roof areas. Variable forms possible due to connectable grid elements. Installation within existing green roof is easily possible.

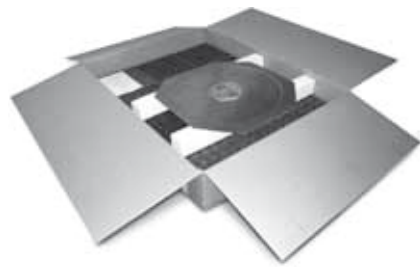

	Art. No.	Dimensions	Unit
Fallnet® SR	9050	ca. 2.00 m × 2.67 m	4 pre-assembled segments + 1 fixing point
Fallnet® SR packed	9053	ca. 2.00 m × 2.67 m	Carton ca. 47 kg 1400 x 1050 x 230 mm
Extension Segment SR for Fallnet® SR	9051	ca. 1.00 m × 1.33 m	1 segment

Application Example (standard)

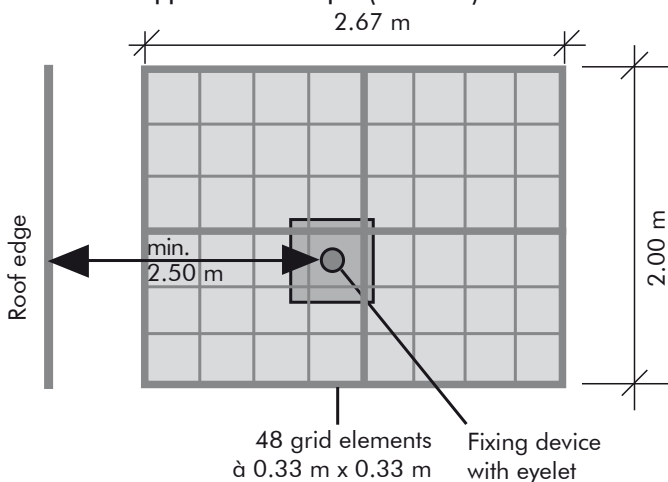

Installation with obstacles

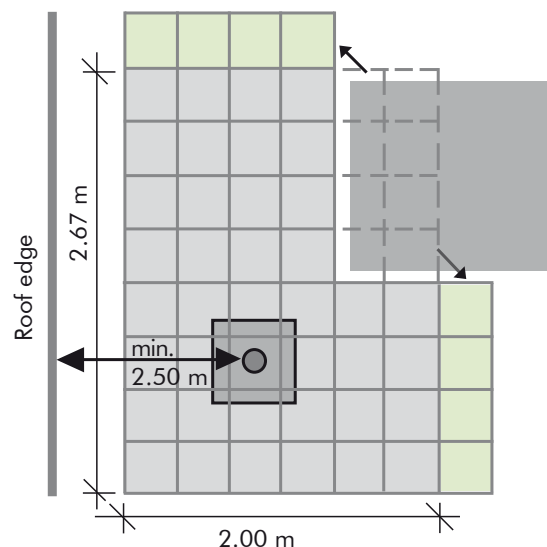

Fall Protection

Fallnet® SR Rail – Fixing device – Horizontal Rail System

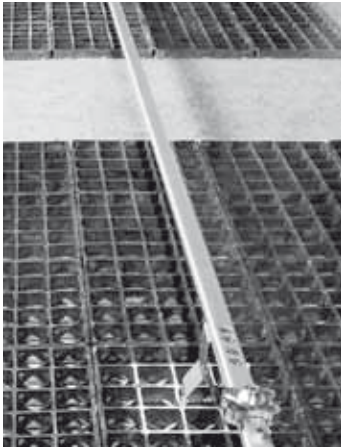

Rail system with horizontally gliding fixing point ("Runner") to be installed with grid elements, rail supports, rail components and superimposed load. Fixing device for fall protection without roof penetration, tested and certified according to European Standard EN 795, Class E

Grid elements made of RC polyethylene, height: ca. 30 mm, dimensions: ca. 2 m × 2 m (start grid element / stop grid element) and 2.00 m × 1.33 m (middle grid element)

Rail support made of stainless steel, height: ca. 175 mm, base plate made of aluminium, ca. 750 mm × 750 mm

Fixing Rail made of high quality aluminium alloy, standard lengths of 3.00 m and 2.00 m, adjusting pieces upon request.

A complete ZinCo Fallnet® SR Rail, even for layer or complex roofs, consists of a combination of only a few unit types. The required rail supports, fixing material and rail connectors belong to the scope of delivery of the single units

	Art. No.	Components/Dimensions	Unit
Base Unit 3	9060	start grid element / stop grid element, 2.00 m x 2.00 m each, rail 3 m, 2 stoppers and runner	Piece
Extension Unit 2	9062	middle grid element, 2.00 m x 1.33 m, rail 2 m	Piece
Extension Unit 3	9061	middle grid element, 2.00 m x 1.33 m, rail 3 m	Piece
Corner Unit 3	9063	middle grid element 2.00 m x 1.33 m, rail 3 m and 90°-corner	Piece
T-Unit 3	9064	stop grid element, 2.00 m x 2.00 m, rail 3 m, 4-way junction and stopper	Piece
Cross Unit 3	9070	stop grid element, 2.00 m x 2.00 m, rail 3 m and 4-way junction	Piece

Planning is easy with our well-designed individual units.

Fallnet® SB 200-Rail – Fixing device – Horizontal Rail System

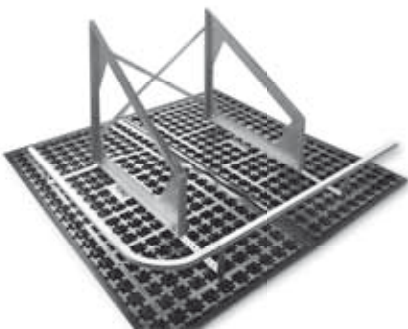

Rail system with horizontally gliding fixing point ("Runner") to be installed in combination with the ZinCo Solar Base SB 200, Solar Base Frame SGR or ZinCo Guardrail Base GB / GB Corner, fixing device for fall protection without roof penetration, tested and certified according to European Standard EN 795, Class E.

	Art. No.	Dimensions	Unit
Rail support	9075		Piece
Fallnet® Rail, Rail 3 m	9065	length 3.00 m	Piece
Fallnet® Rail, Rail 2 m	49064	length 2.00 m	Piece
Fallnet® Rail, Runner	9067	horizontally gliding on the rail	Piece
Fallnet® Rail, Connector	9066		Piece
Fallnet® Rail, Stopper, rigid	9068		Piece
Fallnet® Rail, 90°-Corner	9069	90°	Piece
Fallnet® Rail, 4-Way Junction	49063		Piece

Further accessories are available on request e.g. transportable runners, adjusting pieces, corner pieces in various sizes.

Fall Protection

PPE-Set (Personal Protective Equipment)



Personal Protective Equipment for safe working on roofs, tested and certified to European Standard EN 363, suitable for ZinCo fixing devices "Fallnet®". Consisting of a harness in accordance with European Standard EN 361, 15 m rope (diameter 12 mm), rope shortener, shock absorber, connector and instruction manual delivery in a stable metal case.

	Art. No.	Dimensions	Unit
PPE-Set	9024	Ø 12 mm Rope length ca. 15 m	Set

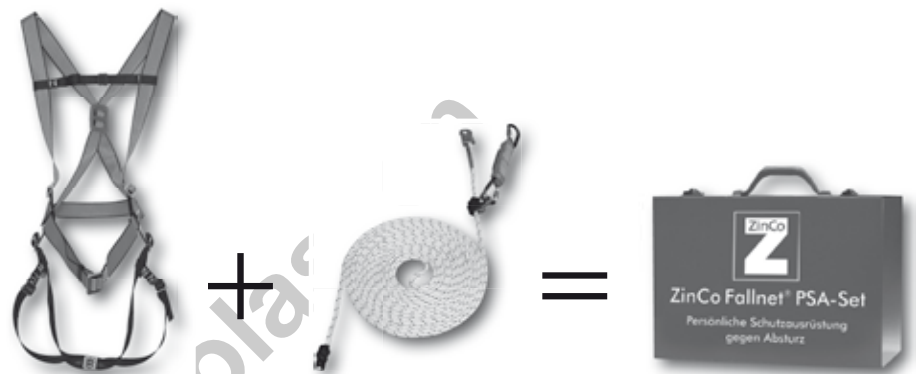

Guardrail Solutions

Guardrail Base GB / GB Corner



Made of profiled recycled hard plastic (ABS), with integrated aluminium profiles on underside, post support(s) with fixing flange made of galvanized steel, suitable for all posts with appropriate fixing flange (hole distance 100 mm × 75 mm), tested according to German Standard DIN 1055-3 for horizontal loads up to 1 kN/m, consisting of:

Guardrail Base GB: length × width ca. 2.00 m × 1.00 m, height: ca. 43 mm, filling volume ca. 16 l/m²

Post support: height: ca. 35 mm from top edge of Guardrail Base GB

Fixing flange: 4 slots for screws M10, hole distance: 100 mm × 75 mm

Total height (Base plate + Post support): ca. 78 mm

	Art. No.	Dimensions	Unit
Guardrail Base GB	3420	ca. 2.00 m × 1.00 m	Piece
Guardrail Base GB corner left	3445	ca. 2.00 m × 1.00 m	Piece
Guardrail Base GB corner right	3446	ca. 2.00 m × 1.00 m	Piece

Combinable with the fixing device Fallnet® SB 200-Rail, making a modified railing base. Other accessories as well as object-specific modifications are available upon request.

Guardrail Solutions

Railing System SG 40-E, stainless steel



handrail +
handrail support



midrail+
midrail support

The SG 40-E stainless steel Railing System is designed by our technical department and tailored to your project needs. We will be happy to give you a detailed and itemised quotation. The following is an example of the different components.

	Art. No.	Dimensions	Unit
Railing Post E	9800	Ø 40 mm × 2 mm, length 1.00 m	Piece
Handrail E	9801	Ø 40 mm × 2 mm, length 3.00 m	Piece
Handrail Support E	9806	Ø 18 mm, ca. 100 mm vertically adjustable	Piece
Handrail Coupling E	9808	for handrail Ø 40 mm	Piece
Midrail E	9802	Ø 12 mm × 1.5 mm, length 3.00 m	Piece
Midrail Support E	9807	with ring and fixing screw	Piece
Midrail Coupling E	9809	for midrail Ø 12 mm	Piece

Further accessories and project-related modifications are available upon request.

Railing System SG 40-S, galvanized steel



handrail +
handrail support



midrail+
midrail support

Functional and stable railing to be installed without drilling, made of galvanized steel, harmonized with the ZinCo Guardrail Base GB / GB Corner. The Railing System can be adjusted to suit the individual project. It consists of several individual components. Depending on the project, components other than those listed may be required.

	Art. No.	Dimensions	Unit
Railing Post S	9850	Ø 42 mm × 3, length 1.20 m	Piece
Handrail S	9851	Ø 42 mm × 3, length 6.00 m	Piece
Handrail Support S	9856	for handrail Ø 42 mm	Piece
Handrail Coupling S	9858	for handrail Ø 42 mm	Piece
Midrail S	9852	Ø 34 mm × 3, length 6.00 m	Piece
Midrail Support S	9857	for midrail Ø 34 mm	Piece
Midrail Coupling S	9859	for midrail Ø 34 mm	Piece

Photovoltaics and Green Roofs

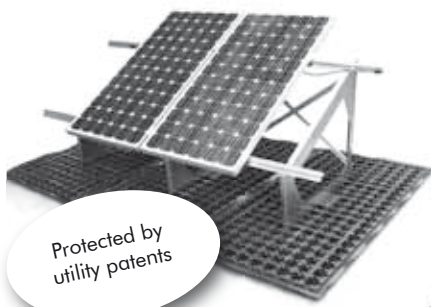

Protected by utility patents

Solar energy generation has become an integral part of the flat roof landscape, in terms of fully exploiting roof areas. A combination of green roof and solar technology is ideal. The green roof build-up functions as additional load to provide stability for the solar panels, even in the case of strong winds and storms. Compared to gravel roofs, green roofs increase the efficiency of the photovoltaic plant due to the comparatively lower ambient temperature.



Please note that solar energy systems on roofs require servicing. Therefore, applicable accident prevention regulations must be adhered to. Fallnet® SB 200-Rail is an appropriate system component. For detailed product information please see page 32.

Solar Base SB 200

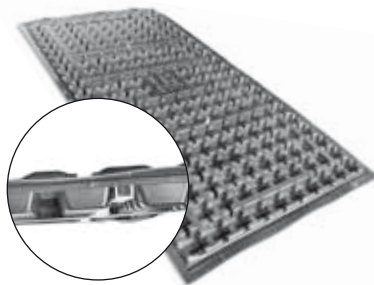

Completely preassembled board (made of thermoformed ABS hard plastic) with integrated aluminium profiles on the underside. Used for ZinCo Solar Base Frame SGR. Element height: ca. 43 mm; weight inclusive reinforced profiles: ca. 7 kg; infill volume: ca. 16 l/m². Fixing material made of stainless steel. Screw thread M 10.

	Art. No.	Dimensions	Unit	Pallet
Solar Base SB 200	3460	ca. 1.00 m × 2.00 m	Board	30 boards

Solar Base Frame SGR 25 / 30 / 45

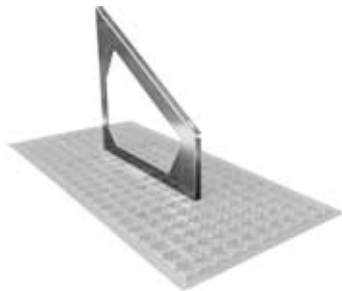

Frame support made of one-piece aluminium, adapted to suit ZinCo Solar Base® SB 200; mounting surface with a 25°/30°/45° slope. Length: 950 mm; weight: 2.6-3.0 kg/piece; material: ALMG III; colour natural aluminium.

	Art. No	Length front	Height back	Height back	Uniform
SGR 25	9702	950 mm	350 mm	800 mm	Piece
SGR 30	9700	950 mm	350 mm	900 mm	Piece
SGR 45	9704	950 mm	350 mm	1310 mm	Piece

Available in any height / inclination upon request

Solar Base Frame SGR 30-HV

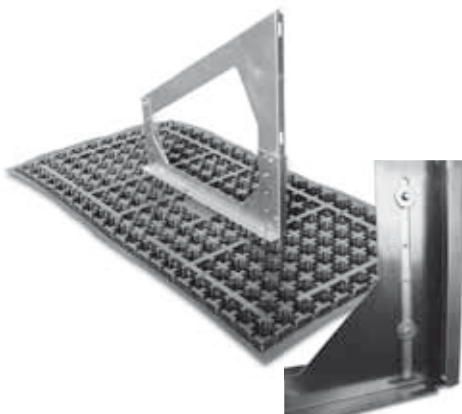

Structurally tested, two-part aluminium frame adapted to fit the ZinCo Solar Base® SB 200. Allows for infinite height-adjustment of the solar base frame up to 210 mm. The angle of inclination of 30° can be adjusted up to ±2°, ensuring optimum adaptation to changing roof pitches and the best-possible positioning of the module.

	Art. No	Length front	Height back	Height back	Uniform
SGR 30-HV	9703	950 mm	350 mm to 560mm	900 mm to 1110 mm	Piece

Accessories Photovoltaics and Green Roofs

Adapter Profile

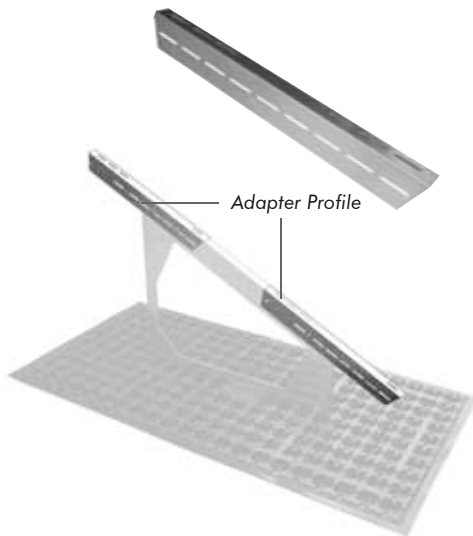

Adapter profile made from one piece which allows for the installation of particularly large modules onto the ZinCo Solar Base Frame SGR. Secured with at least 2 screws per profile. The supporting surface for the adapter profile on the base frame must be at least 250 mm, so the adapter profile will extend beyond this surface by a maximum of 450 mm. Two adapter profiles (above and below) can be used per solar base frame.

	Art. No.	Dimensions	Unit
Adapter Profil	9706	Length 0.7 m	Piece

Wind Bracings



Two pre-drilled flat aluminium profiles to provide a brace for two solar base frames (clearance 1 m); incl. stainless steel reinforcement materials. The wind bracings for photovoltaic systems are installed with a maximum clearance of 10 m (centre line), and for solar thermal systems with a maximum clearance of 7 m. Due to the considerable weight of the thermal systems themselves, additional wind bracings should be installed on the front side. We will be pleased to assist you in establishing the correct position for this product.

Wind Bracing for:	Art. No.	Unit
Solar Base Frame SGR 30	9710	Piece
Solar Base Frame SGR 30-HV	9713	Piece
Solar Base Frame SGR 45, front	9714	Piece
Solar Base Frame SGR 45, back	9715	Piece

Available in any height / inclination upon request

Solar Mounting Profile SMP 40/36



Solar-Mounting Profile SMP 40/36

Connectors incl. screws

Hammer head bolt including anti-twist protection and flange nut

Solar-Mounting Profile SMP 40/36: made of extruded aluminium, natural AlMgSi 0.5 F22, mill finish, with profile channel on upper side, includes connectors and screws. Weight: ca. 0.85 kg/m.

Fastenings for the SMP 40/36: to fix the Solar Mounting Profile SMP 40/36 onto the ZinCo Solar Base Frame (SGR); requires 2 pcs. per SGR; packaging unit contains 50 pcs.; consists of: **stainless steel hammer head bolt M10, anti-twist protection, stainless steel flange nut M10** with serration.

	Art. No.	Dimensions	Unit
Solar Mounting Profile SMP 40/36	9720	Length 6.00 m; B x H: 40 mm x 36 mm	Piece
Fastening means for SMP 40/36	9724		50 pcs. per pack

Vertically adjustable Pedestals

Elefeet® – Pedestals



Infinitely variable, vertically adjustable pedestal, made of solid polypropylene for trouble-free installation of slab pavement on flat and sloped areas. Integrated 3 mm thick joint spacers ensure a linear appearance of the slabs and good drainage function. The adjustable heights from 20 to 400 mm are achieved using a combination of five different standard types (heights of 20, 40, 50, 80 and 140 mm) as well as three extension pieces (10, 25 and 60 mm). The Elefeet® base plate with a diameter of 200 mm distributes the load evenly over the sub-construction.

	Art. No.	Unit	Pack
Elefeet® H 20, vertically adjustable from 20 to 30 mm	9638	Piece	60 pieces
Elefeet® H 40, vertically adjustable from 42 to 65 mm	9639	Piece	60 pieces
Elefeet® H 50, vertically adjustable from 52 to 82 mm	9640	Piece	60 pieces
Elefeet® H 80, vertically adjustable from 84 to 140 mm	9641	Piece	40 pieces
Elefeet® H 140, vertically adjustable from 140 to 230 mm	9643	Piece	40 pieces

Elefeet® Extension Piece

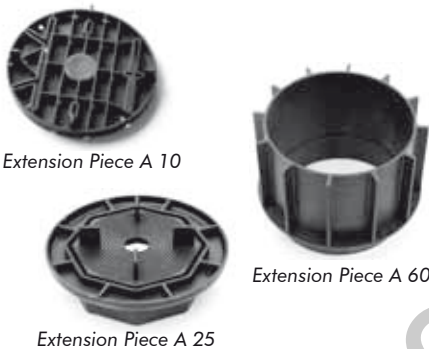

Each of the extension pieces can be combined with any of the four Standard Elefeet® types, thus allowing for infinitely variable build-up height of up to 400 mm. The extension pieces with a height of 25 mm are attached to the header of the Elefeet®. The extension pieces with a height of 60 mm are attached between the header and the base plate of the Elefeet® (maximum 4 pieces).

	Art. No.	Height	Unit	Pack
Extension Piece A 10	9649	10 mm	Piece	60 pieces
Extension Piece A 25	9644	25 mm	Piece	120 pieces
Extension Piece A 60	9645	60 mm	Piece	60 pieces

Elefeet® Adjusting Tool



Efficient height adjuster for Elefeet®. The adjusting tool is made of steel and available as an accessory. The wrench size of the adjusting tool is designed to fit the adjusting ring of the Elefeet®.

	Art. No.	Unit
Elefeet® Adjusting Tool	9647	Piece

Elastosave ES 30



High quality, extra slim protection mat made of recycled rubber, for full-surface installation onto roof waterproofing. The tensile strength of ca. 0.8 N/mm² is twice that of common chip rubber mats, and the elongation at rupture of 125 % is three times greater.

On bitumen layers the surface has to be swept clean. The ES 30 has to be installed with an overlap of 50 mm. On synthetic waterproofings which are compatible with bitumen you can proceed as described above; an additional separation sheet has to be installed if synthetic waterproofing is not compatible with bitumen, an additional separation sheet has to be installed (ZinCo TGF 20). Thickness: ca. 3 mm; weight: ca. 3 kg/m²; temperature resistant from -30 °C to +80 °C.

	Art. No.	Dimensions	Unit	Pallet
Elastosave ES 30	2094	ca. 1.25 m x 8.00 m	10 m ² roll	240 m ²

Accessories for Pedestals

Elefeet® Cantilever Arm Support / Elefeet® Edge Retainer Support



The Elefeet® Cantilever Arm Support and Edge Retainer Support made of galvanized steel are used to lay concrete slabs firmly around the edges. The lack of support around the edges is compensated for by the Cantilever Arm Support, which is placed solidly on at least two Elefeet® pedestals. The weight of the slab pavement ensures the firmness. The upstand on the Elefeet® Edge Retainer Support prevents the slabs from slipping away. The Cantilever Arm Support is fixed to the Elefeet® by slots. A non-slip rubber surface prevents the slabs from sliding off.

	Art. No.	Unit
Elefeet® Cantilever Arm Support width 125 mm, length 800 mm, with non-slip rubber surface	9658	Piece
Elefeet® Edge Retainer Support width 125 mm, length 175 mm, with non-slip rubber surface	9659	Piece

Elefeet® Mitre Cut Support



Used for concrete slabs at edge areas which are not perpendicular to the layout of the pavers. The 170 mm wide Elefeet® Mitre Cut Support is installed parallel to the edge area on the Elefeet®. It supports even small slab pieces. The upfolded edge of 15 mm encloses the concrete slabs. A non-slip rubber surface prevents the slabs from sliding off.

	Art. No.	Length	Unit
Elefeet® Mitre Cut Support	9657	ca. 2.00 m	Piece

Drainage Grill



The drainage grill made of galvanized steel, mesh width ca. 44 mm × 11 mm, as alternative to concrete slabs can be installed over roof outlets or by means of cantilever arm support along facades and allows quick passage of rainwater into the cavity under the covering.

	Art.-Nr.	Outer Dimension	Unit
Terrace Grill TR-F 40 × 40 × 4 (weight: ca. 4,5 kg; aperture dimension: ca. 340 mm × 400 mm)	4210	ca. 400 mm × 400 mm, H = 40 mm	Piece
TR-F 40 × 40 × 5 (weight: ca. 5,0 kg; aperture dimension: ca. 340 mm × 400 mm)	4213	ca. 400 mm × 400 mm, H = 50 mm	Piece
TR-F 50 × 50 × 5 (weight: ca. 6,3 kg; aperture dimension: ca. 440 mm × 500 mm)	4215	ca. 500 mm × 500 mm, H = 50 mm	Piece

Drainage Channel BTR – Stainless Steel



Vertically adjustable channel made of premium stainless steel; grill with oblong hole slots, channel body slotted underneath and on the sides; includes connectors and integrated grill locking mechanism. Channel with ca. 100 mm; vertically adjustable from ca. 40–55 mm.

	Art. No.	Length	Unit
Drainage Channel BTR (weight: ca. 3.6 kg)	4771	ca. 1.00 m	Piece
90°-Corner for BTR (weight: ca. 1.2 kg)	4775	ca. 220 mm × 220 mm	Piece

Accessories for Slab Pavements

Elastoring



Ring-shaped pedestal, made of synthetic rubber, diameter 120 mm, heights available in 5, 10, 15 and 20 mm. With 5 mm integrated joint spacer. Elastoring can be used on roofs without standing water. Slightly uneven roof areas can be adjusted with the various ring heights and the 1 mm Spacer Ring / Slip Protection.

	Art. No.	Height	Unit
Elastoring ER 5	9630	ca. 5 mm	Box with 100 pieces
Elastoring ER 10	9631	ca. 10 mm	Box with 100 pieces
Elastoring ER 15	9632	ca. 15 mm	Box with 100 pieces
Elastoring ER 20	9633	ca. 20 mm	Box with 100 pieces

Spacer Ring / Slip Protection



The 1 mm Spacer Ring / Slip Protection, made of natural rubber, is placed on the Elastoring in order to balance out slight differences in height. It can also be used on the header of Elefeet® pedestals as slip protection.

	Art. No.	Unit
Spacer Ring / Slip Protection	9635	Box with 100 pieces

Load Distributing Board



In order to protect the waterproofing from heavy point loads and the resulting damage, a load distributing rubber board can be used beneath the Elastoring. With the Load Distributing Board (200 x 200 mm), the build-up height is raised by ca. 4 mm.

	Art. No.	Unit
Load Distributing Board thickness 4 mm, dimensions 200 x 200 mm	9634	Box with 100 pieces

Spacer K4 and K3, 5 mm



Spacer with a leg thickness of 5 mm, made of non-rotting plastic, for an easy, precise and uniform installation of slab pavements. The four leg type K4 is used for slab pavement with cross points, the three leg type K3 is used for bond paving or edge areas.

	Art. No.	Unit
Spacer K4, 5 mm, 4 legs	9625	Box with 300 pieces
Spacer K3, 5 mm, 3 legs	9626	Box with 300 pieces

Spacer K4, 3 mm



Spacer with a leg thickness of 3 mm, made of non-rotting plastic, for an easy, precise and uniform installation of slab pavements. The spacer can be used if an Elefeet® can not be placed under a slab cross point (e.g. for edge areas on Elefeet® Cantilever Arm Support or Elefeet® Mitre Cut Support).

	Art. No.	Unit
Spacer K4, 3 mm, 4 legs	9627	Box with 300 pieces



Bild: Nic Lehoux

ZinCo Green Roofing Systems now with European Technical Approval!



As early as May 2008, ZinCo made an application through the DIBt (German Center of Competence in Civil Engineering) suggesting that the EOTA (European Organisation for Technical Approval based in Brussels) create a programme for testing green roof systems. Once this application was granted and a panel of experts had met on a number of occasions, the EOTA passed a CUAP (Common Understanding of Assessment Procedures) in May 2011 which listed the assessment criteria for "Kits for Green Roofs".

In accordance with this CUAP not only well-known parameters such as the

FLL test for root barriers, compressive strength and water flow capacity of drainage elements or physical or chemical properties of substrates were tested. New criteria such as protection provided by protective layers as per EN ISO 13428 or the determination of the water flow capacity of drainage layers as per EN ISO 12958 were also included.

This provided the pre-conditions that would enable the most varied type of green roof systems to receive European Technical Approval.

ZinCo immediately applied to the DIBt for approval for System Build-ups for

both extensive green roofs and for simple intensive and intensive green roofs.

The ETA was issued in June 2013 with the number 13/0668. It includes a considerable number of our proven system build-ups and now allows us to affix the CE mark to these Systems Build-ups. This is, on the one hand, a requirement for unimpeded access to the European market and its Member States. On the other hand it provides planners, clients and others working with our products the guarantee that the required certification has been carried out for a given green roofs system and that the Build-ups and the products are in compliance with the requirements of the approval.

The following System Build-up versions have a European Technical Approval:

	Extensive green roof "Sedum Carpet"	Extensive green roof "Rockery Type Plants"	Simple intensive green roof "Heather with Lavender"	Intensive green roof "Roof Garden"
Root Barrier (optional)	(Root Barrier WSB 100-PO)	(Root Barrier WSB 100-PO)	(Root Barrier WSB 100-PO)	(Root Barrier WSB 100-PO)
Protection Mat	Protection Mat TSM 32 / Protection Mat SSM 45	Protection Mat TSM 32 Protection Mat SSM 45	Protection Mat SSM 45	Protection Mat ISM 50
Drainage Element	Floradrain FD 25-E Fixodrain® XD 20	Floradrain FD 25-E	Floradrain® FD 40-E	Floradrain® FD 40-E
Filter sheet	Filter Sheet SF	Filter Sheet SF	Filter Sheet SF	Filter Sheet SF
Substrate layer	System Substrate Sedum Carpet	System Substrate Rockery Type Plants	System Substrate Heather with Lavender	System Substrate Lawn, System Substrate Roof Garden

The number of European-approved products and systems will be expanded gradually.

What ZinCo can do for you

ZinCo provide a comprehensive package of environmentally sound Green Roof Systems and customized project support, based on:

- 35+ years of experience in Green Roofs
- Tested & proven Green Roof Systems
- Exceeding quality standards & permanent innovation through research and development
- Compliance with relevant international standards
- Experts in structural engineering, landscape architecture, horticulture, material and soil science, ...
- Support from planning to completion (design, specifications, CAD, consultancy, on-site)
- An international network of partners
- Comprehensive warranties

To date, ZinCo Green Roof solutions have inspired planners and contractors throughout the world, providing them with the necessary flexibility to accommodate a wide range of designs and building needs.

Tell us about your project!
We've got the expertise to bring it to life.



**System Build-ups with
European Technical Approval
(Details on page 40)**



ZinCo GmbH · Lise-Meitner-Strasse 2 · 72622 Nuertingen · Germany
Phone: +49 7022/6003-0 · Telefax: +49 7022/6003-100
info@zinco-greenroof.com · www.zinco-greenroof.com